



POWER ANALYZER

CVM-MINI SERIES

INSTRUCTION MANUAL

**M98174001-03-15A
CIRCUTOR, SA**

CONTENTS

1 BASIC INSTRUCTIONS	3
1.1 Checks on receipt.....	3
1.2 Main features.....	3
1.3 Electrical parameters	3
1.4 Other features	4
1.5 Available models	4
2 INSTALLATION AND START-UP.....	5
2.1 Installation	5
2.1.1 Power supply voltage.....	5
2.1.2 Maximum voltage in the voltage measurement circuit	5
2.1.3 Maximum permanent current in the current circuit	5
2.1.4 Transistor output features.....	5
2.1.5 Temperature probe features.....	5
2.1.6 Operating conditions	6
2.1.7 Safety.....	6
2.2 Start-up	6
2.2.1 Description of terminals.....	6
2.2.2 Connection diagrams	7
3 OPERATING MODE.....	7
3.1 Keypad	8
3.2 Default settings.....	8
3.2.1 Default display.....	9
3.2.2 LED Indicators.....	10
4 SETTING SET-UP.....	10
4.1 Measurement Set-up.....	10
4.1.1 Transformation Ratios	11
4.1.1.1 Voltage primary value	11
4.1.1.2 Voltage secondary value	11
4.1.1.3 Current primary value.....	11
4.1.1.4 Current secondary value	12
4.1.2 Measurement in 2 or 4 quadrants	12
4.1.3 Power demand meter parameterisation	13
4.1.3.1 Integrated parameter.....	13
4.1.3.2 Integration period.....	13
4.1.3.3 Clearing power demand meter value	14
4.1.4 Display and backlight	14
4.1.4.1 Selection of screens to be displayed	14
4.1.4.2 Selection of start page	14
4.1.4.3 Backlight (Backlit display).....	15
4.1.5 Clearing energy meter values	15
4.1.6 Setting THd or d	15
4.1.7 Digital output for the transistor (2).....	15
4.1.7.1 Impulse per n KW·h or Kvar·h consumed or generated	16
4.1.7.2 Alarm condition	16
4.2 Communication Set-up.....	19
4.2.1 Default settings	19
4.2.2 Peripheral number	20
4.2.3 Transmission speed	20
4.2.4 Parity	20
4.2.5 Data bits	21
4.2.6 Stop bits	21
4.2.7 Protection of data Set-up using password	21
5 APPENDIX – CVM-MINI-ITF-HAR-RS485-C2 SERIES.....	22
6 MODBUS RTU PROTOCOL	23
6.1 MODBUS memory map	23
6.2 RS485 Connection diagram	26
7 TECHNICAL SERVICE	26

1 BASIC INSTRUCTIONS

This manual is designed to familiarise the user with operating the CVM-MINI power analyzer in order to get the best from its features.

1.1 Checks on receipt.

Please check the following points on receipt of the analyzer:

- The equipment delivered matches your order specifications.
- Check that the equipment has not been damaged during delivery.
- Check that it has the correct instruction manual.



This manual contains information and warnings about the **CVM-MINI** analyzer which must be followed to guarantee the proper operation of all instrument functions and to maintain it in a safe condition.

Installing and maintenance for this analyzer must be carried out by a qualified person.

1.2 Main features

The **CVM-MINI** panel analyzer is a programmable measuring instrument; it offers a series of options for using it, which may be selected from configuration menus on the instrument itself. Before starting the analyzer carefully read sections: power supply, connection and setting and select the most suitable form of operation in order to obtain the required data.

The **CVM-MINI** measures, calculates and displays the main electrical parameters for three-phase, balanced or unbalanced industrial systems.

Measurements are taken in true effective value using the three alternating and neutral voltage inputs and three current inputs to measure $I_N / 1A$ or $I_N / 5A$ secondaries from external measurement transformers.

Figure 1. [CVM-MINI]



The **CVM-MINI** allows the display of all electrical parameters, using the backlit LCD display, showing three instant electrical parameters, maximum or minimum on each page jump.

1.3 Electrical parameters

By using its internal processor, the **CVM-MINI** shows on the screen and through communication (according to model), over 100 parameters, which may be either single-phase or three-phase. These parameters may or may not be displayed on the screen, according to the equipment's preset values.

PARAMETER	UNIT	L1	L2	L3	III
Phase-neutral voltage	V_{f-n}	•	•	•	
Phase-phase voltage	V_{f-f}	•	•	•	
Current	A	•	•	•	••
Frequency	Hz	•			
Active power	kW	•	•	•	•
Reactive power L	kvarL	•	•	•	•
Reactive power C	kvarC	•	•	•	•
Apparent power	kVA	•	•	•	•
Power factor	PF	•	•	•	•
Cos φ	Cos φ				•
Maximum demand	Pd	•	•	•	•
Neutral current	I_N			•	
Voltage THD	% THD - V	•	•	•	
Current THD	% THD - A	•	•	•	
kWh (consumption and generation)	W·h				•
kvarh.L (consumption and generation)	W·h				•
kvarh.C (consumption and generation)	W·h				•
kVAh (consumption and generation)	W·h				•
Harmonic content (V and A) *	%	•	•	•	15 th
Temperature	°C		•		

(•) Available through display and communications.

(••) Only available through communications.

(*) Harmonic content in HAR model.

1.4 Other features

- A small sized instrument with a 85x52x70mm (3 steps).
- Measurement in true effective value (TRMS).
- Instant, maximum, minimum values for each parameter.
- Energy measurer function.
- 1 GW·h counter in consumed energy.
- 100 MW·h counter in generated energy.
- Backlit LCD display.
- Built in RS485 communications (Modbus RTU®).
- Temperature probe built in the equipment.

1.5 Available models

CODE	REFERENCE
M52000	CVM-MINI-Shunt
M52010	CVM-MINI-ITF
M52021	CVM-MINI-ITF-RS485-C2
M52031	CVM-MINI-ITF-HAR-RS485-C2
M52022	CVM-MINI-ITF-Plus-RS485-C2

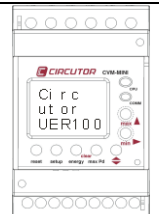

2 INSTALLATION AND START-UP

This manual contains information and warnings about the analyzer which must be followed to guarantee the proper operation of all instrument functions and to maintain it in a safe condition. The analyzer must not be switched on until it is finally connected to the electrical board.

If the equipment is handled in a way not specified by the manufacturer, the equipment's protection may be compromised.

When it is likely that the equipment has lost its protection (i.e. with visible damage), it must be disconnected from the auxiliary supply. In this event, contact a qualified technical service representative.

2.1 Installation

The following features must be taken into consideration before supplying power to the equipment:

2.1.1 Power supply voltage

Standard model power supply:	Single-phase 230 V AC.
Plus model power supply:	85...265 V AC. / 95...300 V DC.
Frequency:	50 Hz ... 60 Hz
Power supply tolerance:	-15 % / +10%
Connection terminals:	14 - 15
Equipment consumption:	3 VA

2.1.2 Maximum voltage in the voltage measurement circuit

Voltage:	300 V ~ AC. phase-neutral 520 V ~ AC. phase-phase
Frequency:	50 Hz ... 60 Hz

2.1.3 Maximum permanent current in the current circuit

In scale $I_N/1A$:	1.2 amperes
In scale $I_N/5A$:	6.0 amperes

2.1.4 Transistor output features

Type NPN transistor:	Opto-insulated / Open Collector
Maximum operating voltage:	24 V DC.
Maximum operating current:	50 mA
Maximum frequency:	5 impulses / second
Impulse length:	100 ms

2.1.5 Temperature probe features

The CVM-MINI has a built in temperature sensor. The sensor has a $\pm 2^\circ\text{C}$ accuracy and a temperature measurement range of -10°C $+50^\circ\text{C}$.

The interior temperature of the CVM-MINI has been estimated at 14.0°C above the interior of the cabinet where it has been installed, if the cabinet has no ventilation. If the cabinet has forced ventilation then the temperature of the CVM is 3.5°C higher.

2.1.6 Operating conditions

Operating temperature: -10 °C / +50°C
 Relative humidity: 5 to 95 % RH (without condensation)
 Altitude: Up to 2000 metres

2.1.7 Safety

Designed for category III installations, 300 V ~ AC (EN 61010).
 Class II double insulation against electric shock protection.

2.2 Start-up

The equipment is mounted on a DIN rail 46277 (EN 50022). All connections must remain inside the electrical board.

Note that when the instrument is switched on, the terminals may be dangerous when touched and opening or removing parts may access dangerous areas. Therefore, the equipment must not be used until it is properly installed.

The equipment must be connected to a power supply circuit protected with gl (IEC 269) or type M fuses between 0.5 and 2 A. It must have an overload/short circuit switch or equivalent device in order to disconnect the equipment from the power supply system. An earth leakage switch or similar device must be fitted to disconnect the equipment from the power supply system. The power supply circuit and the voltage measurement circuit are connected with a cable with a minimum diameter of 1 mm². The secondary line for the current transformer shall have a minimum diameter of 2.5 mm².

2.2.1 Description of terminals

TERMINAL	TERMINAL DESCRIPTION
1	Current input AL1 - S1
2	Current input AL1 - S2
3	Current input AL2 - S1
4	Current input AL2 - S2
5	Current input AL3 - S1
6	Current input AL3 - S2
7	Transistor output RL2
8	Common transistor output
9	Transistor output RL1
10	Measurement VL3
11	Measurement VL2
12	Measurement VL1
13	Neutral V measurement
14	Power supply voltage input
15	Power supply voltage input
A	RS-485 (+)
S	RS-485 (GND)
B	RS-485 (-)

The diagram shows a terminal block with 15 numbered terminals. Terminals 1-6 are for current inputs (AL1-S1, AL1-S2, AL2-S1, AL2-S2, AL3-S1, AL3-S2). Terminals 7-9 are for transistor outputs (RL2, Common, RL1). Terminals 10-13 are for voltage measurements (VL3, VL2, VL1, Neutral). Terminals 14-15 are for power supply voltage input. Terminals A, S, B are for RS-485 communication. The diagram also shows a power supply circuit with L1, L2, L3, and N lines, and a CAT III 300V~ warning symbol.

2.2.2 Connection diagrams

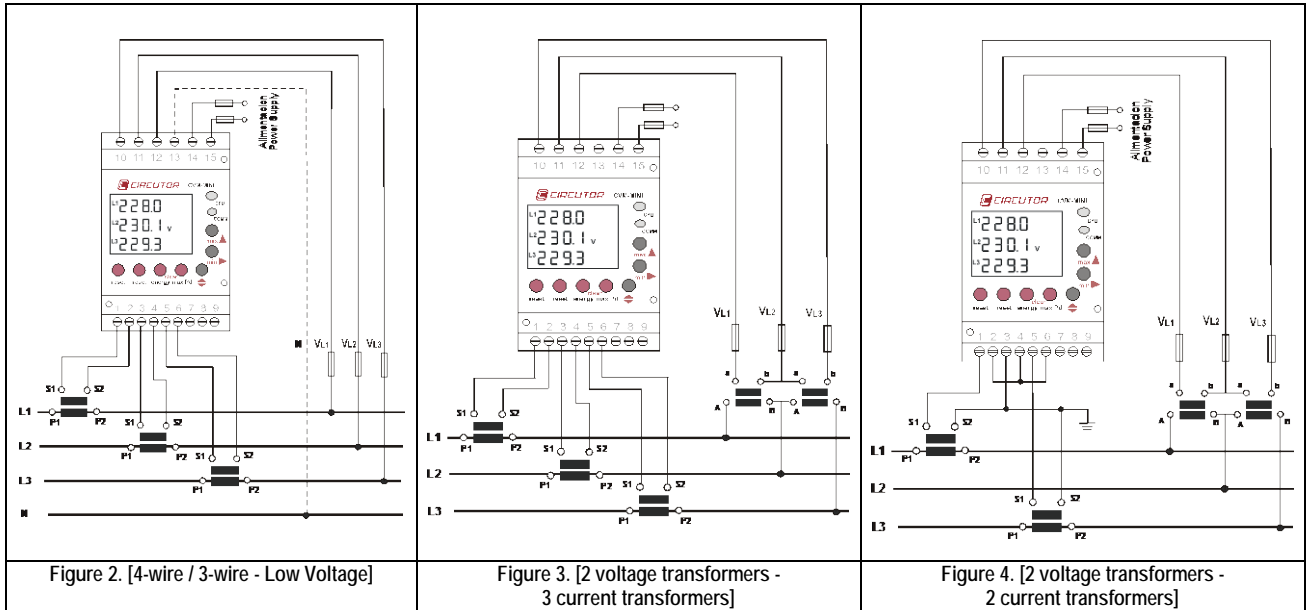

Figure 2. [4-wire / 3-wire - Low Voltage]

Figure 3. [2 voltage transformers - 3 current transformers]

Figure 4. [2 voltage transformers - 2 current transformers]

3 OPERATING MODE

When power is supplied to the **CVM-MINI**, the equipment will start its software interface on the screen showing the version of the firmware and its setting. After a few seconds the equipment is ready to operate and shows all available screens.

Once started the power analyzer will display the programmable electrical parameters via the measurement *Set-up*. If there is no previous setting, the analyzer will display the voltage between phase and neutral for L1, L12 and L1

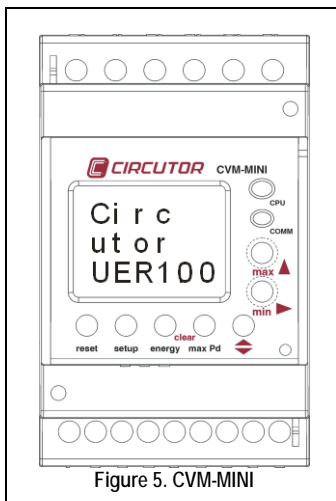

Figure 5. CVM-MINI

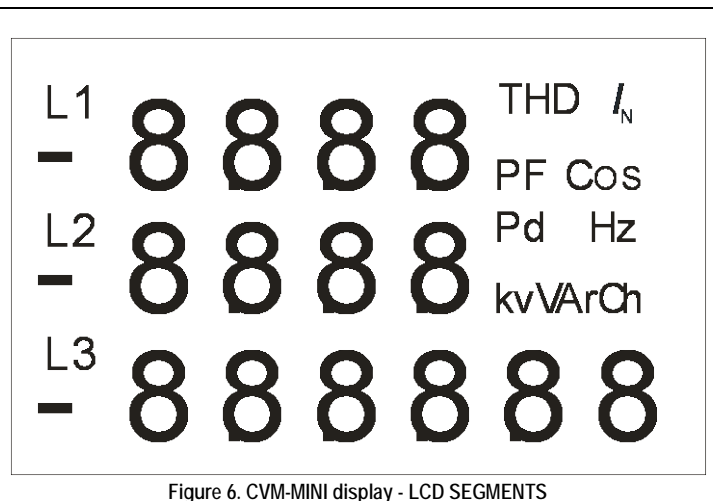









Figure 6. CVM-MINI display - LCD SEGMENTS

3.1 Keypad

The keypad comprises a total of seven silicon buttons which are used to set the equipment. Some buttons have a rapid access function, i.e. entering the *Set Up* interface is not required. Only the rapid access key needs to be pressed to run the function.

Only three of the seven buttons may be pressed when the upper cover is down. This is because the remaining five keys have a high risk factor if they were to be accidentally pressed.

KEY	FUNCTION
 reset	Starting the equipment and clearing maximum and minimum values for all instant parameters. Pressing the <i>Reset</i> key is equivalent to starting the equipment in the absence of voltage.
 setup	Using a long press, after starting the equipment (in the absence of voltage, or after pressing the <i>Reset</i> key), <i>Communication Set-up</i> is accessed. Here the RS485 port parameters may be set and all communication and measurement parameters may be blocked using a password. Using a long press, after starting the equipment (<i>runtime</i> mode), <i>Measurement Set-up</i> is accessed. Each and every parameter for measurement may be changed.
 clear energy	Rapid access function; using a long press (pressed for 5 seconds), all enabled energy counters are cleared (<i>kW·h / kvarL·h / kvarC·h / kVA·h</i> in power consumption or consumption and generation).
 clear max Pd	Rapid access function; using a long press (pressed for 5 seconds), the Power demand parameter previously set in <i>Measurement Set-up</i> is cleared (Power demand) (<i>kW III / kV·A III / A III / A ph</i>).
	Displaying all electrical variables by repeated presses, in <i>runtime</i> mode. In <i>Set-up</i> mode has the function of advancing the setting screens.
 min ▶	Pressing in <i>runtime</i> mode, displays the minimum value of displayed variable/s. In <i>Set-up</i> mode it has the function of moving 1 digit sideways.
 max ▲	Pressing in <i>runtime</i> mode, maximum variable values are displayed. In <i>Set-up</i> mode it has the function of increasing 1 digit cyclically (from 0 to 9), or selecting between two possible preset configurations (for example: yes or no).

3.2 Default settings

The **CVM-MINI** Analyzer has a factory setting for display, communication and measurement. For this reason and due to the fact that this default setting is not valid in nearly all cases, the user must properly set-up the display, measurement and communication in accordance with the installation's requirements.

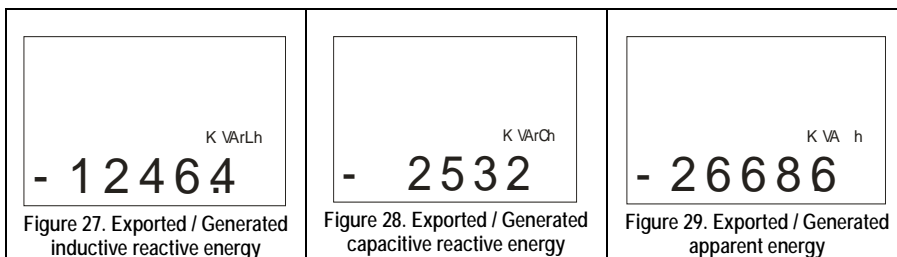
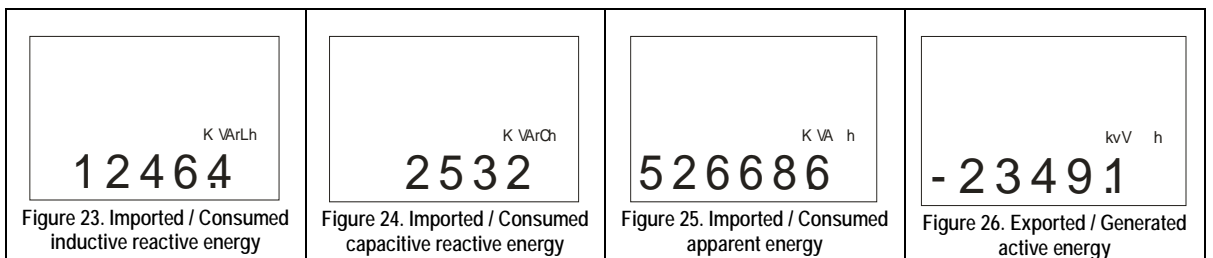
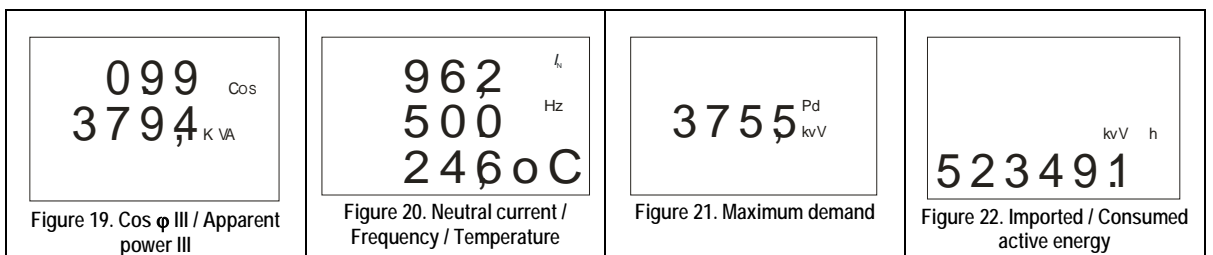
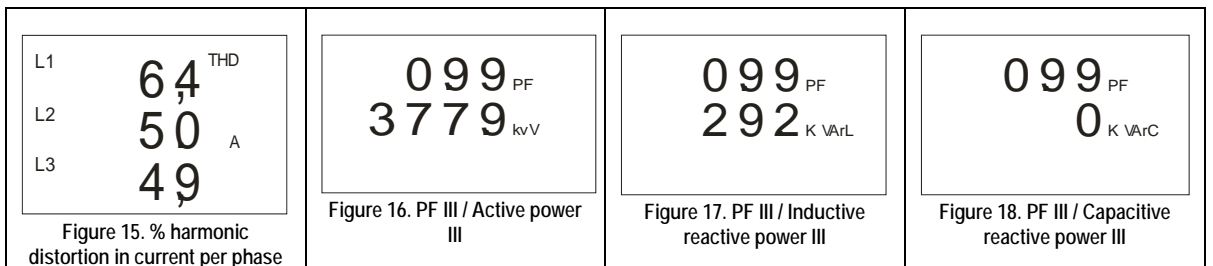
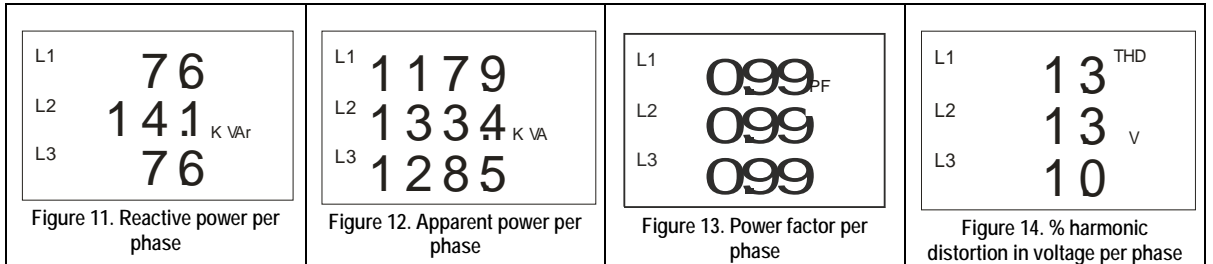
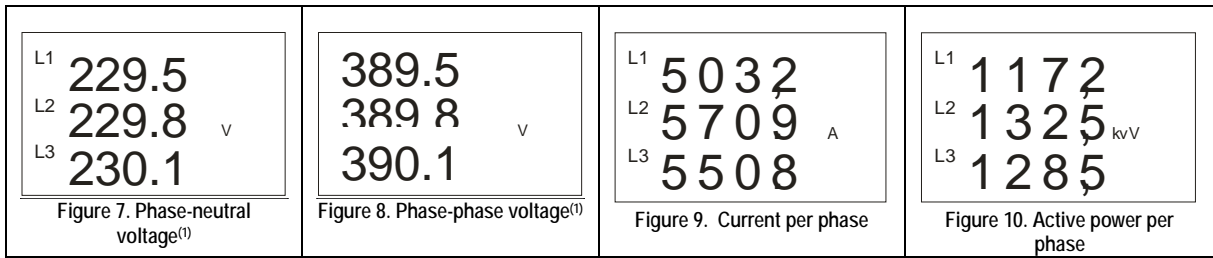

3.2.1 Default display



⁽¹⁾ The device display voltage as:
 0 ... 999 V : 0 ... 999.9 V The dot indicates 1 decimal,
 1000 ... 9999 V : 1000 ... 9999 V without decimal.
 10000 ... 99999 V : 10.00 ... 99.99 V , the dot indicates a multiplying factor of 100.

3.2.2 LED Indicators

The CVM-MINI power analyzer is supplied with two LED indicators which give information on the status of:

LED	FUNCTION
 CPU	The slow flashing of the LED CPU shows that the equipment has auxiliary power supply and is operative. The rapid flashing of the LED CPU shows that there is an internal problem with the start up software.
 COMM	The slow flashing of the COMM LED shows that the equipment is communicating with a master peripheral via its RS485 communications port. The CVM-MINI power analyzer's communications protocol is Modbus RTU.

4 SETTING SET-UP

The **CVM-MINI** power analyzer has two very different *Set-up* configurations which can set the parameters for all the measurement and communication settings.

Measurement set-up: All parameterisation of the equipment's measurements are carried out from this menu; voltage display (phase-neutral or phase-phase voltages and current transformer ratios, setting the power demand meter, setting the start page, backlight setting, returning the energy counters to zero and maximum demand, type of harmonic distortion and setting the transistor outputs.

Communication set-up: All of the analyzer's RS485 RTU Modbus communications are parameterised from this set-up menu. Also the option to enter a password to protect previous data settings in both *Set-ups* is possible from this menu.

4.1 Measurement Set-up

The measurement parameters for the **CVM-MINI** and all its functions are changed from this menu (according to type); it may start the eight energy meters and reset maximum demand (Pd), maximums and minimums recorded.

The analyzer does not store the setting changes until all of the setting has been finished; the analyzer does not store the changes to the settings until the whole setting program has been completed. If  is pressed before the end of the setting, the setting entered is not stored in the memory.

 To access MEASUREMENT Set-Up the SETUP key has to be pressed with a long press with the equipment started until setting mode is entered.

On entering setting mode, the message "SETUP loc", or as a default "SETUP unlo" is displayed for a few seconds indicating that it is in setting and is informing of their status (locked or unlocked respectively).

SETUP unlo: on entering setting mode it is possible to view and change the setting.
SETUP loc: on entering setting mode it is possible to view the parameterisation but it is not possible to change it.

4.1.1 Transformation Ratios



This menu accesses the voltage and current ratios and the voltage and current primary and secondary may be changed.

4.1.1.1 Voltage primary value

The display shows "set PriU" followed by six digits; these allow the setting of the transformer voltage primary.

To write or change the voltage transformer primary value, repeatedly press the  key increasing the value of the digit which is flashing at the time.

When the required value is on the screen, move on to the following digit by pressing , to change the remaining values.

When the last digit has been changed, press  to move back to the first digit, allowing the previously set values to be changed again. To enter the data and access the next setting process, press .





The image shows a rectangular display area with the text "set PriU" on the top two lines and "000001" on the bottom line. The digit "1" is highlighted with a small white box, indicating it is the current digit being set.



Figure 30. Voltage primary ratio

4.1.1.2 Voltage secondary value

The display shows "set SecU" followed by three digits; these allow the setting of the transformer voltage secondary.

To write or change the voltage transformer secondary value, repeatedly press the  key increasing the value of the digit which is flashing at the time.

When the required value is on the screen, move on to the following digit by pressing , to change the remaining values.

When the last digit has been changed, press  to move back to the first digit, allowing the previously set values to be changed again. To enter the data and access the next setting step, press .





The image shows a rectangular display area with the text "set SecU" on the top two lines and "001" on the bottom line. The digit "1" is highlighted with a small white box, indicating it is the current digit being set.

Figure 31. Secondary voltage ratio

4.1.1.3 Current primary value

The display shows "set PriA" followed by five digits; these allow the setting of the transformer current primary.

To write or change the current primary value, repeatedly press the  key increasing the value of the digit which is flashing at the time.

When the required value is on the screen, move on to the following digit by pressing , to change the remaining values.

When the last digit has been changed, press $\ominus \blacktriangleright$ to move back to the first digit, allowing the previously set values to be changed again. To enter the data and access the next setting step, press $\ominus \blacktriangleleft$.



Figure 32. Current primary ratio

4.1.1.4 Current secondary value

Due to the fact that the **CVM-MINI** analyzer has a double scale for measuring the current secondary, the secondary to be measured by the analyzer must be set ($I_N/1A$ or $I_N/5A$).

To select one of the two display measurement options, press the $\ominus \blacktriangleup$ key and the two options will alternate. Once the required secondary of current has been selected, press the $\ominus \blacktriangleleft$ key to enter the data and access the next setting step.



Figure 33. Current secondary value $I_N/5A$



Figure 34. Current secondary value $I_N/1A$

4.1.2 Measurement in 2 or 4 quadrants

The **CVM-MINI** power analyzer may measure in two quadrants (power consumption), or in four quadrants (power consumption and generation). If measurements are only to be taken in power consumption, the two quadrant option is recommended to avoid exported or generated energies being displayed ($-kW \cdot h / -kvarL \cdot h / -kvarC \cdot h / -kVA \cdot h$).

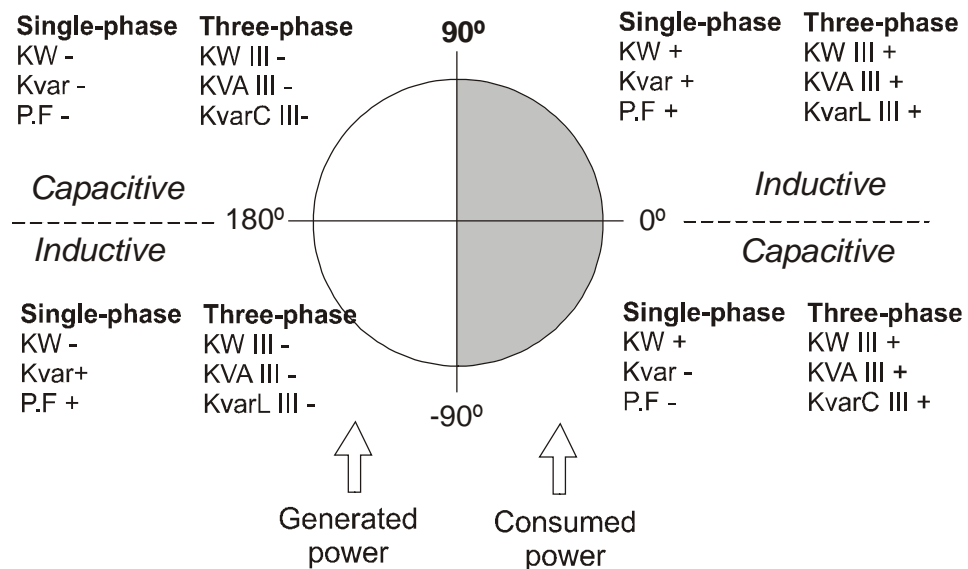

To select one of the two display options (2 or 4 measurement quadrants), press the ●^{max}▲ key and the two options will alternate. Once the required option is selected, press the ●◀ key to enter the data and access the next setting step.



Figure 35. Measurement in 4 quadrants



Figure 36. Measurement in 2 quadrants

4.1.3 Power demand meter parameterisation

The **CVM-MINI** power demand meter is the integration in the time of a preset instant parameter. The amplitude of this window is preset by the integration time.

4.1.3.1 Integrated parameter

The display shows "Pd Code" followed by two digits which identify the code or variable to be integrated as Maximum Demand.

To select one of the four integration parameters available, press the ●^{max}▲ key and the four options will alternate in turn. Once the required option is selected, press the ●◀ key to enter the data and access the next setting step.

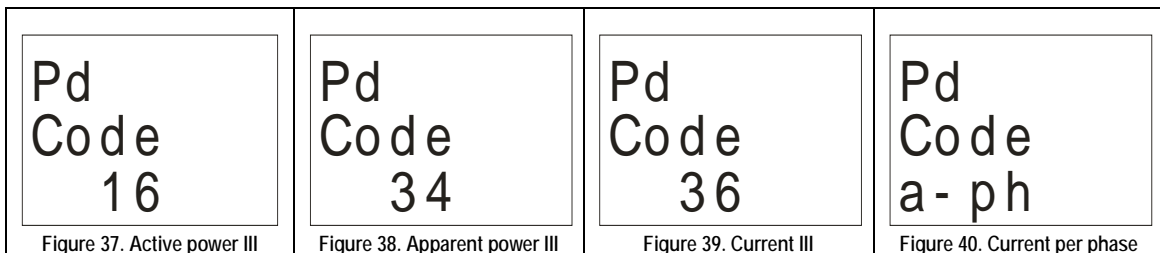

If "Pd Code 00" is selected, the instant integration of the power demand meter will be deactivated.

4.1.3.2 Integration period

The Integration Period of the power demand meter may vary between a minimum of 1 minute up to a maximum of 60 minutes.

To write or change the integration time value, repeatedly press the ●^{max}▲ key increasing the value of the digit which is flashing at the time.

When the required value is on the screen, move on to the following digit by pressing ●^{min}▶, to allow the remaining values to be changed.

When the last digit has been changed, press ●^{min}▶ to move back to the first digit, allowing the previously set values to be changed again. To enter the data and access the next setting step, press ●◀.

4.1.3.3 Clearing power demand meter value



To clear or save maximum demand, press the  key and the two options will alternate. Once the required option is selected, press the  key to enter the data and access the next setting step.



Figure 41. No-clearing power demand meter value







Figure 42. Clearing power demand meter value

4.1.4 Display and backlight



4.1.4.1 Selection of screens to be displayed

Due to the fact that the **CVM-MINI** power analyzer has a large number of default screens (as shown in section 3.2.1 Default display), the user has the option of setting a personalised display by selecting screens to be displayed.

The display shows as default “def page yes”; the  key has to be pressed to proceed to the personalised display option. The analyzer will show “def page no” on the screen; to enter the data and proceed to this setting, press .

Once the personalisation option has been entered, by using  key the screens shown in section 3.2.1 Default display will be displayed in turn. By using the  button, the screen to be displayed is selected. Select “yes” or “no” respectively.

4.1.4.2 Selection of start page

In order to select the equipment’s preferred start up screen, repeatedly press the  key up to display the screen to be selected. Once the required option is selected, press the  key to enter the data and access the next setting step.

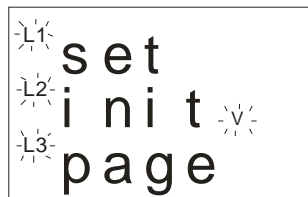



Figure 43. Select preferred page

Rotating function: Using the rotating display function, the Power analyzer automatically displays every available screen for five seconds each.

The  must be used to enter the rotating display function when all electrical parameters are flashing at the same time.

4.1.4.3 Backlight (Backlit display)

The time in which the back lighting will be on after the last use is set by using the keypad in this menu. The display is permanently on if 00 is set.

4.1.5 Clearing energy meter values



Clearing energy meters refers to the four consumed or imported energy meters. To select clear these meters of *kw·h*, press the  key and the two options will alternate. Once the required option is selected, press the  key to enter the data and access the next setting step.



Figure 44. No-clearing energy meters



Figure 45. Clearing energy meters

4.1.6 Setting THd or d

Harmonic distortion rate measurements may be made using two measurement options: the effective value or the fundamental value.



To select one of the two calculation options, press the  key and the two options will alternate. Once the required option is selected, press the  key to enter the data and access the next setting step.



Figure 46. Harmonic distortion value for the effective value (RMS)



Figure 47. Harmonic distortion value for the fundamental value

4.1.7 Digital output for the transistor (2)

Two types of setting may be made using the **CVM-MINI's** digital transistor outputs:

- Impulse per n *kw·h* or *kvar·h* (Energy): the value for the energy consumed or generated may be set to generate an impulse.
- Alarm condition: associates a parameter to a digital output, setting a maximum, minimum and delay (*delay*) for the trip condition.





In the event that no condition needs to be set, the 00 code is typed and entered using the  key.

4.1.7.1 Impulse per n KW·h or Kvar·h consumed or generated

In order to generate an impulse for consumed *n kW·h*, the energy meter to be used has to be selected:

PARAMETER	SYMBOL	CODE
Active energy III	<i>kW·h III</i>	31
Inductive reactive energy III	<i>KvarL·h III</i>	32
Capacitive reactive energy III	<i>KvarC·h III</i>	33
Apparent energy III	<i>kVA·h III</i>	44
Active energy generated III	<i>kW·h III (-)</i>	45
Inductive reactive energy generated III	<i>KvarL·h III (-)</i>	46
Capacitive reactive energy generated III	<i>KvarC·h III (-)</i>	47
Apparent energy generated III	<i>kVA·h III (-)</i>	48

Once the energy code has been selected and entered using the  key, the watts-time per impulse is entered or as a default, kilowatts-time per impulse.

For entering the watts-time rate per impulse, repeatedly press the  key increasing the value of the digit which is flashing at the time. When the required value is on the screen, move on to the following digit by pressing , to allow the remaining values to be changed. When the last digit has been changed, press  to move back to the first digit, allowing the previously set values to be changed again. To enter the data and access the next setting step, press .

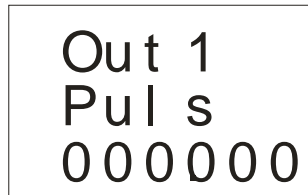

Figure 48. Watts / impulse

4.1.7.2 Alarm condition

In order to link an alarm condition to an energy parameter, the code for the selected parameter has to be entered. A list of electrical parameters and their codes is shown below.

PARAMETER	PHASE	SYMBOL	CODE
Phase-neutral voltage	L1	V 1	01
Current	L1	A 1	02
Active power	L1	kW 1	03
Reactive power L/C	L1	KvarL/C 1	04
Apparent power	L1	kV·A	38
Power factor	L1	PF 1	05
% THD V	L1	THD V1	25
% THD A	L1	THD A1	28
Phase-neutral voltage	L2	V 2	06
Current	L2	A 2	07
Active power	L2	kW 2	08
Reactive power L/C	L2	KvarL/C 2	09
Apparent power	L2	kV·A	39
Power factor	L2	PF 2	10
% THD V	L2	THD V2	26
% THD A	L2	THD A2	29
Phase-neutral voltage	L3	V 3	11
Current	L3	A 3	12
Active power	L3	kW 3	13
Reactive power L/C	L3	KvarL/C 3	14
Apparent power	L3	kV·A	40
Power factor	L3	PF 3	15
% THD V	L3	THD V3	27
% THD A	L3	THD A3	30
Temperature	-	°C	41

PARAMETER	SYMBOL	CODE	PARAMETER	SYMBOL	CODE
Active power III	kW III	16	cos φ three-phase	cos φ	19
Inductive power III	kvarL III	17	Power factor III	PF III	20
Capacitive power III	kvarC III	18	Frequency	Hz	21
Active energy	kW·h	31	L1- L2 Voltage	V 12	22
Inductive reactive energy	Kvarh·L	32	L2- L3 Voltage	V 23	23
Capacit. reactive energy	Kvarh·C	33	L3- L1 Voltage	V 31	24
Apparent power III	kV·A III	34	Temperature	°C	41
Maximum demand	Md (Pd)	35	Maximum demand L1	Md (Pd)	35*
Current III	AIII	36	Maximum demand L2	Md (Pd)	42*
Neutral current	I _N	37	Maximum demand L3	Md (Pd)	43*

* Variables only valid if the Maximum Demand for current has been set per phase.

There are also some codes which refer to the three-phases at the same time (Function OR). If one of these variables has been selected, the alarm will go off when any of the three-phases, or all three at the same time, match the preset conditions.

PARAMETER	SYMBOL	CODE
Phase-neutral voltage	V1 / V2 / V3	90
Current	A1 / A2 / A3	91
Active power	kW1 / kW2 / kW3	92
Reactive power	Kvar1 / kvar2 / kvar3	93
Apparent power	kV·A1 / kV·A2 / kV·A3	98
Power factor	PF1 / PF2 / PF3	94
Phase-phase voltage	V12 / V23 / V31	95
% THD V	Thd1 / Thd2 / Thd3 V	96
% THD I	Thd1 / Thd2 / Thd3 A	97

Once the Alarm Condition code has been selected and the data entered using the key, the *maximum value*, *minimum value* and the *delay* in seconds (hysteresis) for the alarm condition must be entered.

For entering the maximum, minimum and hysteresis values, repeatedly press the key increasing the value of the digit which is flashing at the time. When the required value is on the screen, move on to the following digit by pressing , to allow the remaining values to be changed. When the last digit has been changed, press to move back to the first digit, allowing the previously set values to be changed again. In order to enter one of the pieces of data, press the key. Once the delay has been set, press the key entering the data and ending the setting.

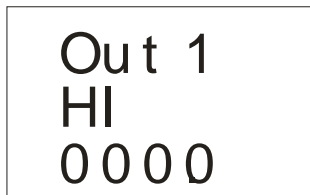

Figure 49. Maximum value

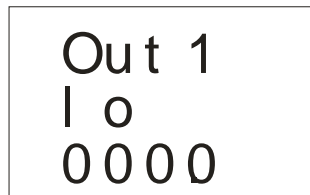

Figure 50. Minimum value

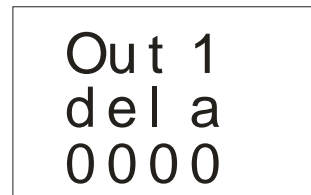

Figure 51. Hysteresis / Delay

Setting the number 2 digital output is shown on the display as “Out 2”. This must be set by using the settings shown below.

MIN +	MAX + max > min	<table style="width: 100%; border-collapse: collapse;"> <tr> <td style="text-align: center;">ON</td> <td style="text-align: center;">OFF</td> <td style="text-align: center;">ON</td> </tr> <tr> <td style="text-align: center;"> ----- </td> <td style="text-align: center;"> ===== </td> <td style="text-align: center;"> ----- </td> </tr> <tr> <td style="text-align: center;">0</td> <td style="text-align: center;">Min</td> <td style="text-align: center;">Max</td> </tr> </table>	ON	OFF	ON	-----	=====	-----	0	Min	Max
ON	OFF	ON									
-----	=====	-----									
0	Min	Max									
MIN +	MAX + max < min	<table style="width: 100%; border-collapse: collapse;"> <tr> <td style="text-align: center;">OFF</td> <td style="text-align: center;">ON</td> <td style="text-align: center;">OFF</td> </tr> <tr> <td style="text-align: center;">=====</td> <td style="text-align: center;"> ----- </td> <td style="text-align: center;">=====</td> </tr> <tr> <td style="text-align: center;">0</td> <td style="text-align: center;">Max</td> <td style="text-align: center;">Min</td> </tr> </table>	OFF	ON	OFF	=====	-----	=====	0	Max	Min
OFF	ON	OFF									
=====	-----	=====									
0	Max	Min									
MIN --	MAX +	<table style="width: 100%; border-collapse: collapse;"> <tr> <td style="text-align: center;">ON</td> <td style="text-align: center;">OFF</td> <td style="text-align: center;">ON</td> </tr> <tr> <td style="text-align: center;"> ----- </td> <td style="text-align: center;"> ===== </td> <td style="text-align: center;"> ----- </td> </tr> <tr> <td style="text-align: center;">Min</td> <td style="text-align: center;">0</td> <td style="text-align: center;">Max</td> </tr> </table>	ON	OFF	ON	-----	=====	-----	Min	0	Max
ON	OFF	ON									
-----	=====	-----									
Min	0	Max									
MIN +	MAX --	<table style="width: 100%; border-collapse: collapse;"> <tr> <td style="text-align: center;">OFF</td> <td style="text-align: center;">ON</td> <td style="text-align: center;">OFF</td> </tr> <tr> <td style="text-align: center;">=====</td> <td style="text-align: center;"> ----- </td> <td style="text-align: center;">=====</td> </tr> <tr> <td style="text-align: center;">Max</td> <td style="text-align: center;">0</td> <td style="text-align: center;">Min</td> </tr> </table>	OFF	ON	OFF	=====	-----	=====	Max	0	Min
OFF	ON	OFF									
=====	-----	=====									
Max	0	Min									
MIN --	MAX -- max > min	<table style="width: 100%; border-collapse: collapse;"> <tr> <td style="text-align: center;">ON</td> <td style="text-align: center;">OFF</td> <td style="text-align: center;">ON</td> </tr> <tr> <td style="text-align: center;"> ----- </td> <td style="text-align: center;"> ===== </td> <td style="text-align: center;"> ----- </td> </tr> <tr> <td style="text-align: center;">Min</td> <td style="text-align: center;">Max</td> <td style="text-align: center;">0</td> </tr> </table>	ON	OFF	ON	-----	=====	-----	Min	Max	0
ON	OFF	ON									
-----	=====	-----									
Min	Max	0									
MIN --	MAX -- max < min	<table style="width: 100%; border-collapse: collapse;"> <tr> <td style="text-align: center;">OFF</td> <td style="text-align: center;">ON</td> <td style="text-align: center;">OFF</td> </tr> <tr> <td style="text-align: center;">=====</td> <td style="text-align: center;"> ----- </td> <td style="text-align: center;">=====</td> </tr> <tr> <td style="text-align: center;">Max</td> <td style="text-align: center;">Min</td> <td style="text-align: center;">0</td> </tr> </table>	OFF	ON	OFF	=====	-----	=====	Max	Min	0
OFF	ON	OFF									
=====	-----	=====									
Max	Min	0									

Activating the outputs of the programmable values as Maximums and Minimums.

4.2 Communication Set-up

One or more **CVM-MINI** instruments may be connected to a computer or PLC in order to automate a production process or an energy control system. As well as the usual operation of each instrument, this system may centralize data at one single point; for this reason the **CVM-MINI** has an RS-485 communication output.

If more than one instrument is connected to one single series line (RS-485), it is necessary to assign to each a number or address (from 01 to 255) so that the central computer or PLC sends the appropriate requests to these addresses for each peripheral.

From communication *Set-up*, the **CVM-MINI**'s communication parameters may be displayed and/or changed; this may match these parameters to the requirements of the system topologies and/or applications.

The analyzer does not store the setting changes until all of the setting has been finished. If it is *Reset* before the end of the setting, the setting entered is not stored in the memory.

☞ To access the COMMUNICATION Set-up, first press the *Reset* key and immediately press the *Set-up* key for a long time to enter a setting.

On entering setting mode the message "SETUP inic" appears for a few seconds, informing the user that the equipment has entered communications display or setting mode.



Figure 52. Protocol information

Using this information screen, the equipment is informing the user that the Communication protocol via the RS-385 series port is standard MODBUS©.

To enter setting mode, press the  key.

4.2.1 Default settings

This menu option allows the automatic selection of a predefined communication parameter; the default preset parameters are: Peripheral number 1, speed 9,600 bps, parity NO, data bits 8 and stop bit 1.

If a different preset communication setting is not required, "no" should be selected.



To select one of the two options, just press the  key and the two options will alternate. Once the required option is selected, press the  key to enter the data and access the next setting step.



Figure 53. Non-standard communication parameters



Figure 54. Predefined communication parameters

4.2.2 Peripheral number





The peripheral number varies between 0 and 255 (0 and FF in hexadecimal). To write or change the number of the peripheral, repeatedly press the  key increasing the value of the digit which is flashing at the time. When the required value is on the screen, move on to the following digit by pressing , to allow the remaining values to be changed. When the last digit has been changed, press  to move back to the first digit, allowing the previously set values to be changed again. To enter the data and access the next setting step, press .



Figure 55. Peripheral number

4.2.3 Transmission speed



The transmission speed of RS485 communication bus may be: 1,200 bps, 2,400 bps, 4,800 bps, 9,600 bps or 19,200 bps. To select one of the transmission speeds available, press the  key and the four options will alternate in turn. Once the required option is selected, press the  key to enter the data and access the next setting step.



Figure 56. Transmission speed

4.2.4 Parity



Parity may be selected, even or odd; to select the type of parity, press the  key and the three options will alternate in turn. Once the required option is selected, press the  key to enter the data and access the next setting step.



Figure 57. Parity

4.2.5 Data bits

7 or 8 data bits may be selected; to select the number of bits, press the key and the two options will alternate in turn. Once the required option is selected, press the key to enter the data and access the next setting step.

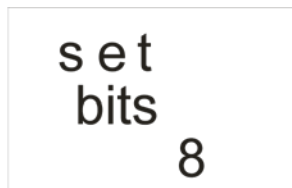

Figure 58. Data bits

4.2.6 Stop bits

1 or 2 stop bits may be selected; to select the number of bits, press the key and the two options will alternate in turn. Once the required option is selected, press the key to enter the data and access the next setting step.



Figure 59. Stop bits

4.2.7 Protection of data Set-up using password

This menu option aims to protect the data set in *Measurement Set-up*. As a default the equipment does NOT protect data with the “unlo” option. By pressing the key the data is entered and setting the equipment is finalised. If, on the other hand, the parameters in *Measurement Set-up* are to be protected, the option “Loc” has to be selected using the key and then the key pressed. The protection password as a default will always be 1234; any other password code entered will be incorrect.



Figure 60. Password request to protect Set-up data

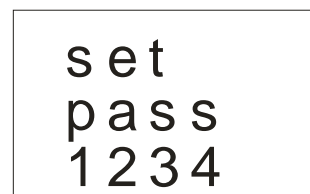





Figure 61. Enter password to protect Set-up data

For entering the password, repeatedly press the key increasing the value of the digit which is flashing at the time.

When the required value is on the screen, move on to the following digit by pressing , to allow the remaining values to be changed. When the last digit has been changed, press  to move back to the first digit, allowing the previously set values to be changed again. In order to enter the password, press the  key. Once the password has been set, press the  key entering the data and ending the setting.

In the event that the measurement SETUP parameters are to be changed again, the equipment has to be first unlocked by the same procedure (position “unlo”), and the appropriate changes are made.

5 APPENDIX – CVM-MINI-ITF-HAR-RS485-C2 SERIES

The **CVM-MINI** Series has an analyzer for the harmonic content up to the 15th harmonic in voltage and current, showing the content on the LCD display. Therefore, the HAR has a high number of display screens, where the value of the current and voltage fundamental and the content of each harmonic may be seen.

The equipment’s display diagram is obtained by using the following procedure:

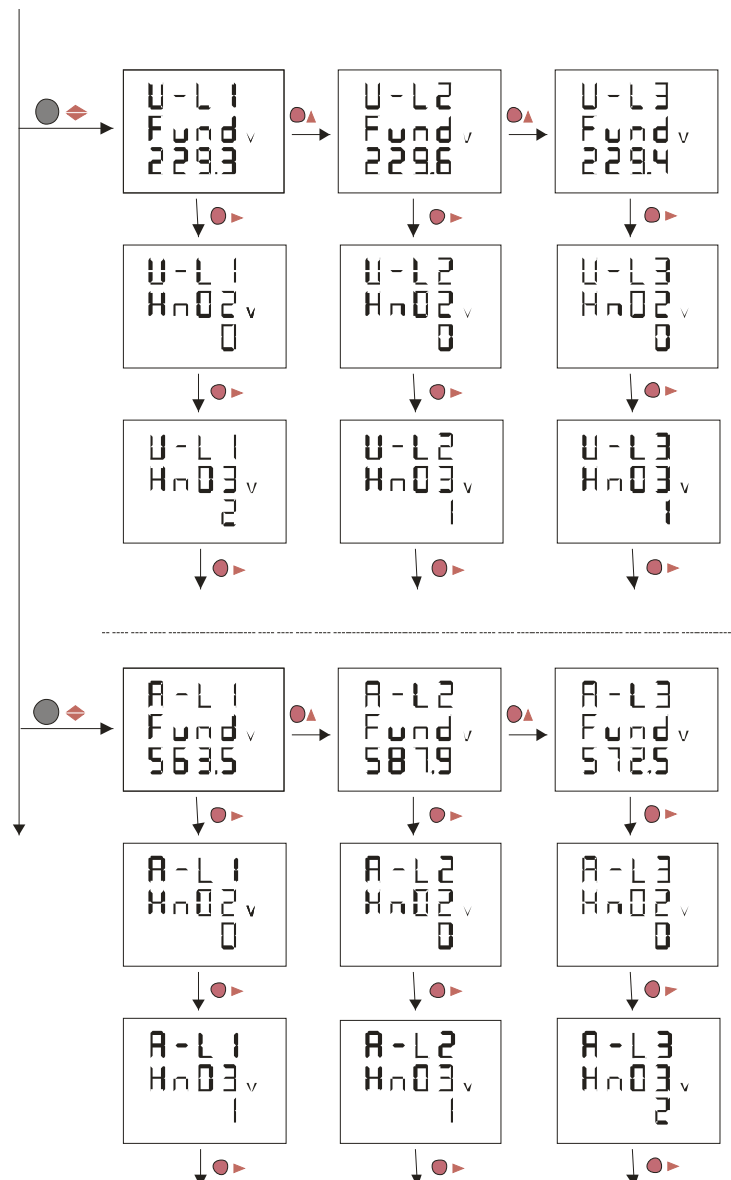

Figure 62. Display of Harmonic Content in Voltage and Current

6 MODBUS RTU PROTOCOL

The **CVM-MINI** power analyzer communicates using the MODBUS® protocol. In the MODBUS protocol the RTU (Remote terminal Unit) mode is used; each 8-bit per byte in a message contains two 4-bits hexadecimal characters.

The format for each byte in RTU mode is:

Code	8 bit binary, hexadecimal 0-9, A-F. 2 hexadecimal characters contained in each 8-bit field in the message.
Bits per byte	8 data bits.
Field Check-Error	CRC Type (Cyclical Redundancy Check).

Modbus functions used:

Function 01	Reading the status of the relays.
Function 03 and 04	Reading n Words (16 bits-2 bytes). Function used for reading the electrical parameters that the CVM-MINI is measuring. All electrical parameters are long with 32 bits, because of this two Words are required to request each parameter. (4 bytes - XX XX XX XX)
Function 05	Writing a relay.

6.1 MODBUS memory map

PARAMETER	SYMBOL	Instant	Maximum	Minimum	Units
Voltage phase	<i>V L1</i>	00-01	60-61	C0-C1	<i>V x10</i>
Current	<i>A L1</i>	02-03	62-63	C2-C3	<i>mA</i>
Active power	<i>kW L1</i>	04-05	64-65	C4-C5	<i>w</i>
Reactive power	<i>Kvar L1</i>	06-07	66-67	C6-C7	<i>w</i>
Apparent power	<i>kV·A L1</i>	4A-4B	AA-AB	10A-10B	
Power factor	<i>PF L1</i>	08-09	68-69	C8-C9	<i>x 100</i>
Voltage phase	<i>V L2</i>	0A-0B	6A-6B	CA-CB	<i>V x10</i>
Current	<i>A L2</i>	0C-0D	6C-6D	CC-CD	<i>mA</i>
Active power	<i>kW L2</i>	0E-0F	6E-6F	CE-CF	<i>w</i>
Reactive power	<i>Kvar L2</i>	10-11	70-71	D0-D1	<i>w</i>
Apparent power	<i>kV·A L2</i>	4C-4D	AC-AD	10C-10D	<i>w</i>
Power factor	<i>PF L2</i>	12-13	72-73	D2-D3	<i>x 100</i>
Voltage phase	<i>V L3</i>	14-15	74-75	D4-D5	<i>V x10</i>
Current	<i>A L3</i>	16-17	76-77	D6-D7	<i>mA</i>
Active power	<i>kW L3</i>	18-19	78-79	D8-D9	<i>W</i>
Reactive power	<i>Kvar L3</i>	1A-1B	7A-7B	DA-DB	<i>W</i>
Apparent power	<i>kV·A L3</i>	4E-4F	AE-AF	10E-10F	<i>w</i>
Power factor	<i>PF L3</i>	1C-1D	7C-7D	DC-DD	<i>x 100</i>
Temperature	<i>°C</i>	50-51	B0-B1	110-111	<i>°C x 10</i>

PARAMETER	SYMBOL	Instant	Maximum	Minimum	Units
Active power III	<i>kW III</i>	1E-1F	7E-7F	DE-DF	<i>w</i>
Inductive power III	<i>KvarL III</i>	20-21	80-81	E0-E1	<i>w</i>
Capacitive power III	<i>KvarC III</i>	22-23	82-83	E2-E3	<i>w</i>
Cos ϕ III	<i>Cos ϕ III</i>	24-25	84-85	E4-E5	<i>x 100</i>
Power factor III	<i>PF III</i>	26-27	86-87	E6-E7	<i>x 100</i>

Frequency	<i>Hz</i>	28-29	88-89	E8-E9	<i>Hz x 10</i>
Voltage line L1-L2	<i>V12</i>	2A-2B	8A-8B	EA-EB	<i>V x10</i>
Voltage line L2-L3	<i>V23</i>	2C-2D	8C-8D	EC-ED	<i>V x10</i>
Voltage line L3-L1	<i>V31</i>	2E-2F	8E-8F	EE-EF	<i>V x10</i>
% THD V L1	<i>%THD VL1</i>	30-31	90-91	F0-F1	<i>% x 10</i>
% THD V L2	<i>%THD VL2</i>	32-33	92-93	F2-F3	<i>% x 10</i>
% THD V L3	<i>%THD VL3</i>	34-35	94-95	F4-F5	<i>% x 10</i>
% THD A L1	<i>%THD AL1</i>	36-37	96-97	F6-F7	<i>% x 10</i>
% THD A L2	<i>%THD AL2</i>	38-39	98-98	F8-F9	<i>% x 10</i>
% THD A L3	<i>%THD AL3</i>	3A-3B	9A-9B	FA-FB	<i>% x 10</i>

Apparent power III	<i>KvaIII</i>	42-43	A2-A3	102-103	<i>w</i>
Maximum demand	<i>Md (Pd)</i>	44-45	A4-A5	104-105	<i>w/VA/mA</i>
Three-phase current (average)	<i>A_AVG</i>	46-47	A6-A7	106-107	<i>mA</i>
Neutral current	<i>In</i>	48-49	A8-A9	108-109	<i>mA</i>
Maximum demand A2	<i>Md (Pd)</i>	52-53	B2-B3	112-113	<i>mA</i>
Maximum demand A3	<i>Md (Pd)</i>	54-55	B4-B5	114-115	<i>mA</i>

MODBUS VARIABLES

PARAMETER	SYMBOL	Instant	Maximum	Minimum	Units
Active energy	<i>kW·h III</i>	3C-3D	9C-CD	FC-FD	<i>w·h</i>
Inductive reactive energy	<i>kvarL·h III</i>	3E-3F	9E-9F	FE-FF	<i>w·h</i>
Capacitive reactive energy	<i>kvarC·h III</i>	40-41	A0-A1	100-101	<i>w·h</i>
Apparent energy	<i>kVA·h III</i>	56-57	B6-B7	116-117	<i>w·h</i>
Active energy generated	<i>kW·h III (-)</i>	58-59	B8-B9	118-119	<i>w·h</i>
Inductive energy generated	<i>kvarL·h III (-)</i>	5A-5B	BA-BB	11A-11B	<i>w·h</i>
Capacitive energy generated	<i>kvarC·h III (-)</i>	5C-5D	BC-BD	11C-11D	<i>w·h</i>
Apparent energy generated	<i>kVA·h III (-)</i>	5E-5F	BE-BF	11E-11F	<i>w·h</i>

* Recordings available in HAR model		MODBUS VARIABLES			
PARAMETER	SYMBOL	L1	L2	L3	Units
Harmonic content in VOLTAGE		Instant	Maximum	Minimum	
RMS current	V	2AE-2AF	2CC-2CD	2EA-2EB	Vx10
Harmonic 2		2B0-2B1	2CE-2CF	2EC-2ED	%
Harmonic 3		2B2-2B3	2D0-2D1	2EE-2EF	%
Harmonic 4		2B4-2B5	2D2-2D3	2F0-2F1	%
Harmonic 5		2B6-2B7	2D4-2D5	2F2-2F3	%
Harmonic 6		2B8-2B9	2D6-2D7	2F4-2F5	%
Harmonic 7		2BA-2BB	2D8-2D9	2F6-2F7	%
Harmonic 8		2BC-2BD	2DA-2DB	2F8-2F9	%
Harmonic 9		2BE-2BF	2DC-2DD	2FA-2FB	%
Harmonic 10		2C0-2C1	2DE-2DF	2FC-2FD	%
Harmonic 11		2C2-2C3	2E0-2E1	2FE-2FF	%
Harmonic 12		2C4-2C5	2E2-2E3	300-301	%
Harmonic 13		2C6-2C7	2E4-2E5	302-303	%
Harmonic 14		2C8-2C9	2E6-2E7	304-305	%
Harmonic 15		2CA-2CB	2E8-2E9	306-307	%

* Recordings available in HAR model		MODBUS VARIABLES			
PARAMETER	SYMBOL	L1	L2	L3	Units
Harmonic content in CURRENT		Instant	Maximum	Minimum	
RMS current	A	1F4-1F5	212-213	230-231	mA
Harmonic 2		1F6-1F7	214-215	232-233	%
Harmonic 3		1F8-1F9	216-217	234-235	%
Harmonic 4		1FA-1FB	218-219	236-237	%
Harmonic 5		1FC-1FD	21A-21B	238-239	%
Harmonic 6		1FE-1FF	21C-21D	23A-23B	%
Harmonic 7		200-201	21E-21F	23C-23D	%
Harmonic 8		202-203	220-221	23E-23F	%
Harmonic 9		204-205	222-223	240-241	%
Harmonic 10		206-207	224-225	242-243	%
Harmonic 11		208-209	226-227	244-245	%
Harmonic 12		20A-20B	228-229	246-247	%
Harmonic 13		20C-20D	22A-22B	248-249	%
Harmonic 14		20E-20F	22C-22D	24A-24B	%
Harmonic 15		210-211	22E-22F	24C-24D	%

6.2 RS485 Connection diagram

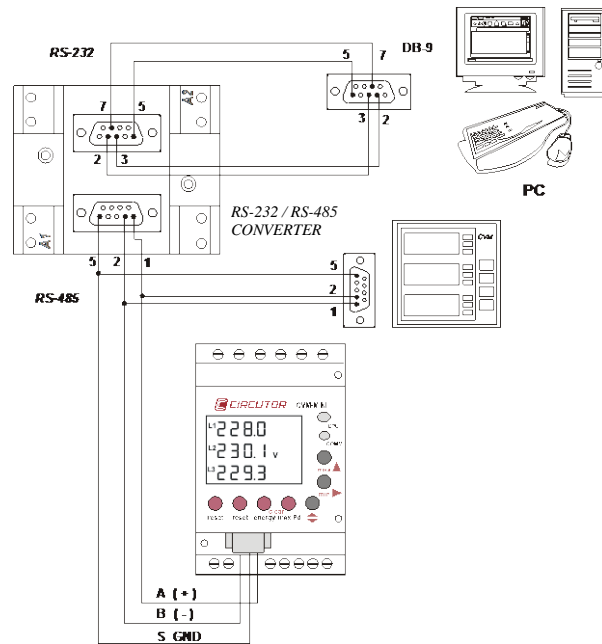

7 TECHNICAL SERVICE

In the event of any equipment failure or any operational queries please contact the technical service of CIRCUTOR S.A.

CIRCUTOR S.A. - After sales service.

Vial Sant Jordi, s/n

08232 - Viladecavalls.

Tel. – 902 449 459 (Spain) / +34 937 452 919 (Out of Spain)

E-mail - sat@circutor.es