



**Power Analyzer
CVM-NRG96**



User manual
Extended version

Checks on receipt.

This manual assists in the installation and use of the **CVM NRG 96** power analyzer so that the best possible use can be gained from it. On receipt of the equipment check the following:

- The equipment corresponds to the specifications in your order.
- Check that the equipment has not been damaged during delivery.
- Check that it has the correct instruction manual.



For safety reasons it is essential that anyone installing or handling the **CVM NRG 96** follow the usual safety procedures as well as the specific warnings in this instruction manual. Installing and maintenance for this analyzer must be carried out by a qualified person.

TABLE OF CONTENTS

General features	page	4
Installation and start-up	page	6
Power supply voltage	page	6
Maximum voltage in the measurement circuit	page	7
Maximum admissible current	page	7
Features of the transistor	page	7
Operating conditions	page	7
Safety	page	7
Connection diagrams	page	9
Operation	page	13
Setting menus	page	14
Programming SETUP Measurement	page	15
Status of Setup Measurement	page	15
Simple or compound voltages	page	16
Transformation ratios	page	16
Programming the power demand meter	page	18
Programming the main page and preferred energy	page	19
Backlight (Back-lighting of the display)	page	20
Deletion of Energy meters	page	21
Programming THD or d	page	21
Transistor digital output	page	22
Programming SETUP Communications	page	26
Setting communication parameters	page	27
Protection of SETUP measurement	page	30
MODBUS protocol RTU	page	31
MODBUS memory map	page	32
RS485 connection	page	35
FAQ'S (Frequently Asked questions)	page	36

General features

The CVM-NRG 96 panel analyzer is a programmable measuring instrument; it offers a series of options for using it, which may be selected from configuration menus on the instrument itself. Before starting the analyzer carefully read sections: power supply, connection and setting and select the most suitable form of operation in order to obtain the required data.



The CVM-NRG 96 measures, calculates and displays the main electrical parameters in three phase, balanced or unbalanced industrial systems.

Measurements are taken in true effective value using the three alternating voltage inputs and three current inputs to measure 5 A secondaries from external measurement toroids.

With its processor, the measurement station allows simultaneous analysis of:

MAGNITUDE	UNIT	L1	L2	L3	III
Simple Voltage	V	•	•	•	
Compound voltage	V	•	•	•	
Current	A	•	•	•	••
Frequency	Hz	•			
Active power	kW	•	•	•	•
Reactive Power L	kvarL	•	•	•	•
Reactive Power C	kvarC	•	•	•	•
Apparent Power	kVA				•
Power Factor	PF	•	•	•	
Cos φ	Cos φ				•
Maximum Demand	Pd			•	
Neutral Current	I _N			•	
Voltage THD	% THD – V	•	•	•	
Current THD	% THD – A	•	•	•	
kWh (consumption and generation)	W·h				•
kvarh.L (consumption and generation)	W·h				•
kvarh.C (consumption and generation)	W·h				•
kVAh (consumption and generation)	W·h				•
Harmonic decomposition (V and A) *	%	•	•	•	15th

- ✓ (•) Available through display and communications.
- ✓ (••) Only available through communications.
- ✓ (*) Harmonic decomposition in model HAR.

The CVM-NRG 96 allows the display of all electrical parameters shown above, using the back-lit LCD display, showing 4 instant electrical parameters, maximum or minimum on each page jump.

Other features:

- Small sized instrument (96x96x50).
- Measurement in true effective value.
- Instant, maximum, minimum values for each parameter.
- Energy measurer function.
 - 1 GW·h in consumed energy.
 - 100 MW·h in generated energy.
- Backlit LCD display.
- RS485 communications (Modbus RTU®) included.

Available models:

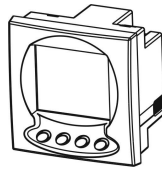

CVM-NRG96	CODE
CVM-NRG96	M51800
CVM-NRG96-ITF	M51900
CVM-NRG96-ITF-RS485-C	M51911
CVM-NRG96-ITF-RS485-C-HAR	M51B11
CVM-NRG96-ITF-P-RS485-C	M51A11

Installation and start-up

This manual contains information and warnings that must be followed by the user to ensure the safe operation of the equipment and to maintain it in a safe condition. The analyzer must not be switched on until it is finally attached to the electrical board.

IF THE EQUIPMENT IS HANDLED IN A WAY NOT SPECIFIED BY THE MANUFACTURER, THE EQUIPMENT'S PROTECTION MAY BE COMPROMISED

When it is likely that the equipment has lost its protection (with visible damage), it must be disconnected from the auxiliary supply. In this event, contact a qualified technical service representative.

Installing the equipment

Check the following points before switching the equipment on:

- a) Power supply voltage.
- b) Maximum voltage in the measurement circuit.
- c) Maximum admissible current.
- d) Features of the transistor (*digital output*).
- e) Operating conditions.
- f) Safety.

A. Power supply voltage

- *Standard version:*

- Power supply	:	230 V AC.
- Frequency	:	50-60 Hz
- Power supply tolerance	:	-15% / +10%
- Connection board	:	Terminals 1-2 (Power Supply)
- Consumption of the equipment	:	5 V·A

- *Version Plus:*

- Power supply	:	85...265 V AC. // 95...300 V DC.
- Frequency	:	50-60 Hz
- Connection board	:	Terminals 1-2 (Power Supply)
- Consumption of the equipment	:	5 V·A

B. Maximum voltage in the measurement circuit:

- Voltage : 300 V ~AC. phase-neutral
520 V ~AC. phase-phase
- Frequency : 45...65 Hz

C. Maximum admissible current:

- Current : External transformers In /5A.

D. Transistor features(output):

- NPN Type : Opto-isolated Transistor /Open Collector
- Maximum operating voltage: 24 V.DC.
- Maximum operating current: 50 mA
- Maximum frequency : 5 pulses / second
- Pulse length : 100 ms

E. Operating conditions:

- Operating temperature : -10 °C / +50°C
- Relative humidity : 5 to 95 % HR (without condensation)
- Altitude : up to 2,000 metres

F. Safety:

- Designed for category III installations 300 V ~AC. (EN 61010).
- Protection against electric shock by class II double isolation.

Installation

Installation for the equipment is by panel(*panel drill* $92^{+0.8} \times 92^{+0.8}$ m.m., according to DIN 43 700). All connections must remain inside the electrical board.

Bear in mind that when the equipment is connected, the terminals may be dangerous if touched. Opening covers or removing parts may access parts which are dangerous if touched. The equipment must not be used until it is fully installed.

The equipment must be connected to a power supply circuit protected with *gI* (IEC 269) or type M fuses between 0.5 and 2 A. It must have an overload/short circuit switch or equivalent device in order to disconnect the equipment from the power supply. The power supply circuit and the voltage measurement circuit is connected with a cable with a minimum cross section of 1 mm².

The secondary line for the current transformer shall have a minimum cross section of 2.5 mm².

Terminal list

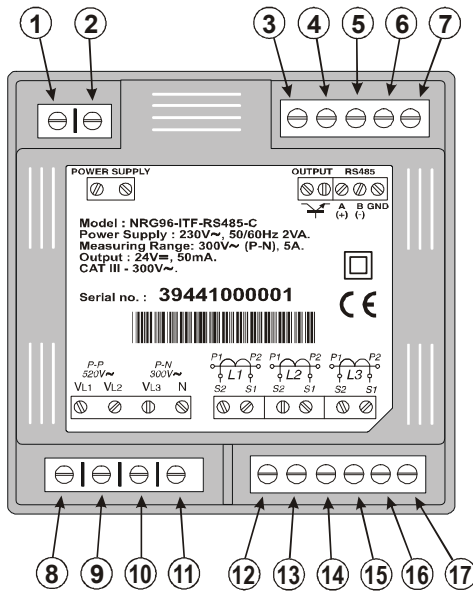

No.	Terminal description
1	Power supply voltage input
2	Power supply voltage input
3	Transistor output RL1
4	Transistor output RL2
5	RS-485 (+)
6	RS-485 (-)
7	RS-485 (GND)
8	Measurement VL1
9	Measurement VL2
10	Measurement VL3
11	Neutral measurement
12	Current input AL1 – S2
13	Current input AL1 – S1
14	Current input AL2 – S2
15	Current input AL2 – S1
16	Current input AL3 – S2
17	Current input AL3 – S1

Note: Internally terminals 13, 15 and 17 are joined to terminal 6, Neutral (in no isolated model).
The current inputs... / 5 A are isolated in model ITF.

Connection diagrams

- A. Three phase system measurement with 4 wire connection (Low Voltage) and three external current transformers.

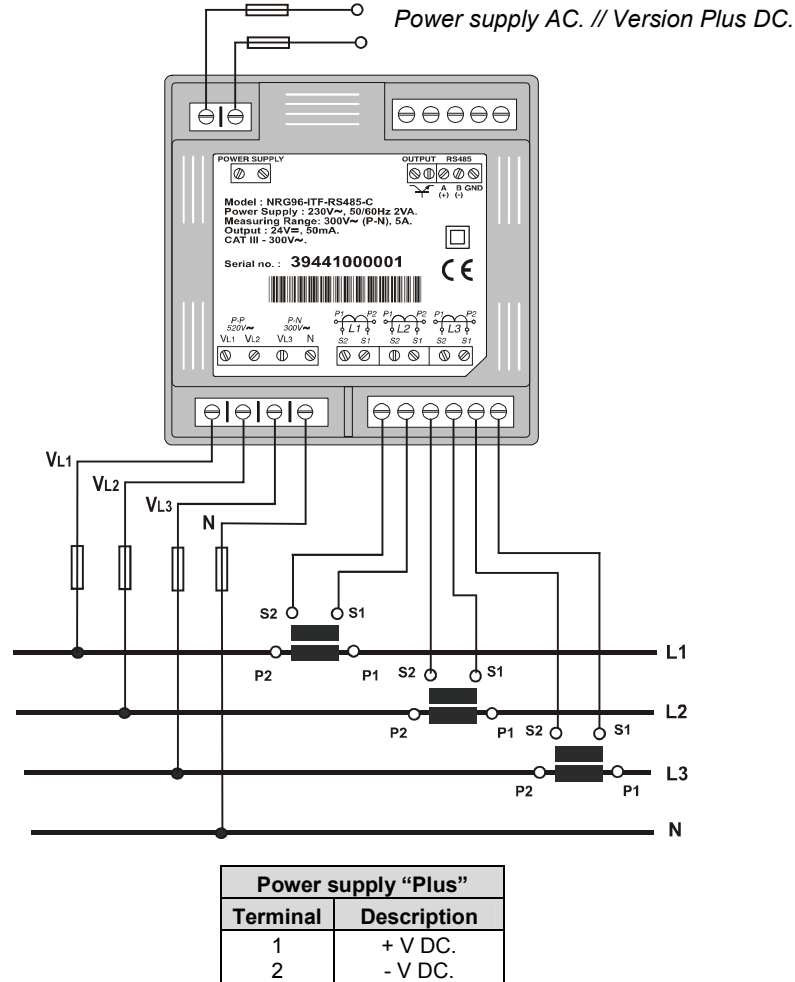

- B. Three phase system measurement with 3 wire connection (Low Voltage) and three external current transformers.

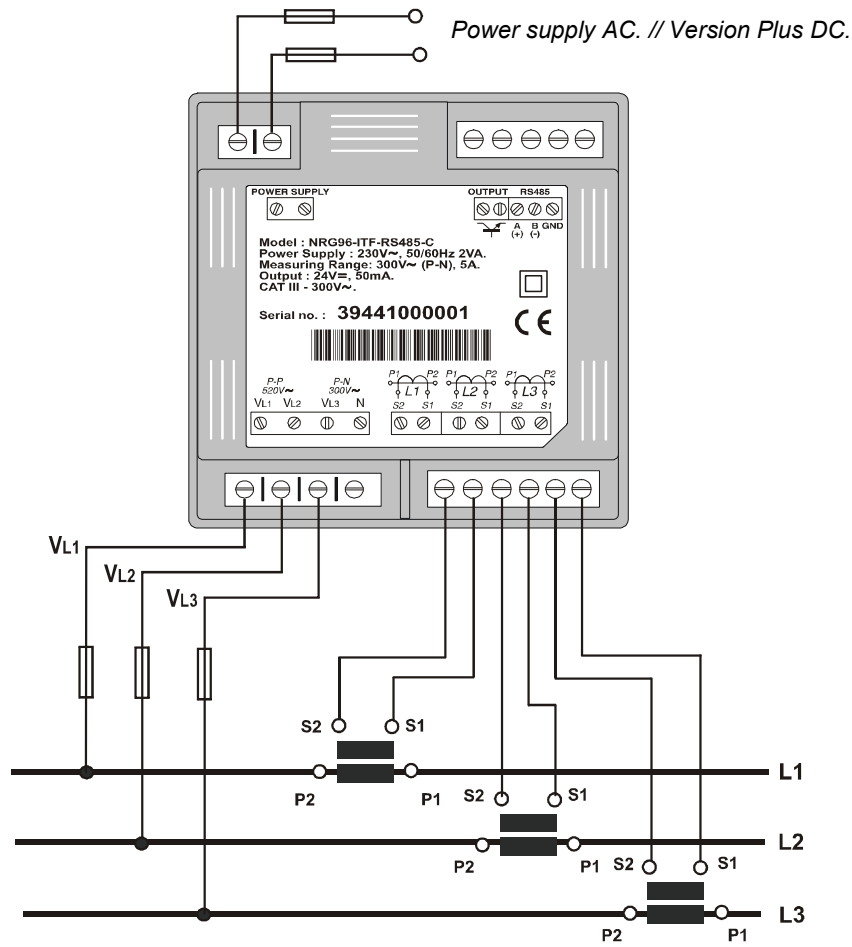

- C. Three phase system measurement with 3 wire connection using 2 transformers and three external current transformers.

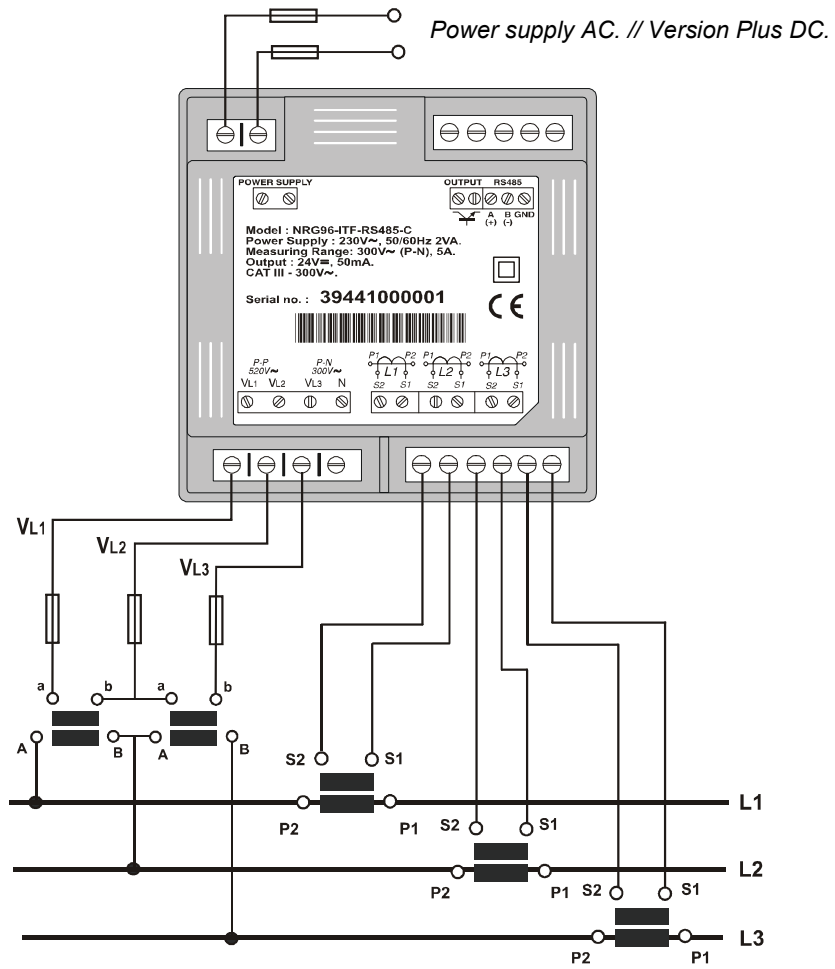

- D. Three phase system measurement with 3 wire connection using 2 voltage transformers and two external current transformers.

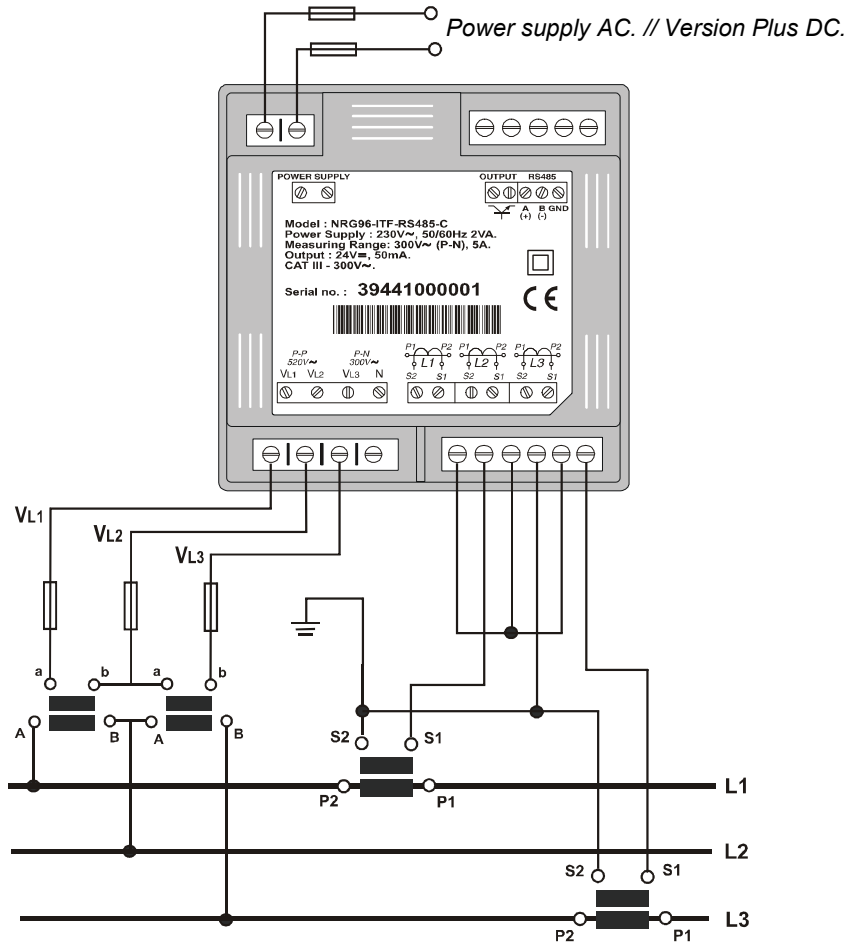

Operation

Generic functions of the front keypad:

Key *Reset*:

- Starting the equipment.
- Deletion of Maximum and Minimum values.
- This is equivalent to starting the equipment in the absence of voltage.



Key *Display*:

- Displaying all variables by repeated presses.
- Function key in set-up menu: pressing the *Display* key moves forward through different screens, both on the *configuration menu* and the *communications* menu.
- In runtime mode, a long press (keeping the key pressed for 2 seconds), displays the energy meters:

✓ Active Energy	Consumed
✓ Reactive Inductive Energy	Consumed
✓ Reactive Capacitive Energy	Consumed
✓ Apparent energy	Consumed
✓ Active energy	Generated
✓ Inductive Reactive Energy	Generated
✓ Reactive Capacitive Energy	Generated
✓ Apparent Energy	Generated



Key *Max* and *Min*:

- Display of *maximums* or *minimums* for each variable displayed; this function is only valid while the key is being pressed. Once it is stopped being pressed the instant values appears again after five seconds.
- Function keys in set-up menu: the **MIN** key selects the code or parameter to be changed and the **MAX** key assigns the corresponding code and/or variable.



Configuration Menu

The CVM-NRG96 analyzer has two configuration menus:

1. **MEASUREMENT SETUP:**

from this menu, the user can set the measurement parameters and the analyzer's different display options.

- Measurement Setup Status (locked or unlocked)
- Simple or compound voltages
- Transformation ratios
- Power Demand Meter Setting
- Main page and preferred energy setting
- Backlight (Backlit display)
- Deletion of Energy meters
-
-

2. **COMMUNICATIONS SETUP:**

Configures the communication parameters: speed, parity, stop bits, etc; it also accesses the locking menu using a password in the measurement SETUP.

- Communication parameters setting
- Protection of measurement SETUP.

Setting **MEASUREMENT SETUP**

The parameters for the CVM-NRG 96 and all its functions are displayed and changed from this menu (according to type); it may start the eight energy meters and return maximum demand to zero (Pd), maximums and minimums recorded. The analyzer does not store the changes to the settings until the whole setting program has been completed. If it is **RESET** before the end of the setting process, the configuration entered is not stored in the memory.



To access **MEASUREMENT SETUP** the **MAX** and **MIN** keys have to be pressed at the same time until setting mode is entered.

On entering setting mode the message "SEtUP unLo", or as a default "SEtUP Loc" is displayed for a few seconds indicating that we are in setting and informing of their status (locked or unlocked).

- SEtUP unLo
On entering setting mode it is possible to see and change the setting.
- SEtUP Loc
On entering setting mode it is possible to see the setting but not possible to change it.

Once in **MEASUREMENT SETUP** using the keypad, it is possible to select the different options and enter the variables:

The keypad functions to carry out the setting are as follows:

- The  key enters the data and moves on to the following menu.
- The **MAX** key allows the selection of the different options in the menu or increases a digit in the event that a variable has been entered.
- The **MIN** key is used to move the cursor among the digits.

1. Simple or Compound Voltages

- *Simple Voltages* U 1 U 2 U 3
- *Compound Voltages* U 12 U 23 U 3 1



To select one of the two display options, just press the **MAX** key and the two options will alternate.

Once the required option is selected, press the  key to enter the data and access the next setting step moving on to the next setting step.

2. Transformation Ratios

- *Transformer voltage primary*

The display shows "SEt UoLt PrL_" followed by three digits; these allow the setting of the *transformer voltage primary*.

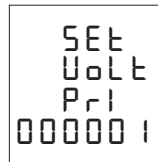

To write or change the value of the transformer primary value repeatedly press the **MAX** key increasing the value of the digit which is flashing at the time.

When the required value is on the screen, move on to the following digit by pressing **MIN**, to allow the remaining values to be changed.

When the last digit has been changed, press **MIN** to move back to the first digit, allowing the previously set values to be changed again.

To enter the data and access the next setting step, press .

- *Transformer Voltage Secondary*

The display shows "SEt UoLt SEc_" followed by three digits; these allow the setting of the *transformer voltage secondary*.



To write or change the value of the transformer secondary value repeatedly press the **MAX** key increasing the value of the digit which is flashing at the time.

When the required value is on the screen, move on to the following digit by pressing **MIN**, to allow the remaining values to be changed.

When the last digit has been changed, press **MIN** to move back to the first digit, allowing the previously set values to be changed again.

To enter the data and access the following setting step, press .

- *Transformer current primary*

The display shows "SEt Curr Pri" followed by five digits; these allow the setting of the *transformer current primary*.



To write or change the value of the transformer primary value repeatedly press the **MAX** key increasing the value of the digit which is flashing at the time.

When the required value is on the screen, move on to the following digit by pressing **MIN**, to allow the remaining values to be changed.

When the last digit has been changed, press **MIN** to move back to the first digit, allowing the previously set values to be changed again.

To enter the data press .

3. Setting the Power Demand Meter

- *Magnitude to Integrate*

The display shows "SEt Pd CodE" followed by two digits which identify the code or variable to be integrated as *Maximum Demand*.

None		00
Three phase active power	kW III	16
Three phase apparent power	kV·A III	34
Three phase current	A III	36
Current per phase	A1 - A2 - A3	R - Ph

The **MAX** key allows the selection of the Maximum Demand variable to be integrated.

Once selected to access the next setting step, press .

- *Integration Period*

The display shows "SEt Pd PEr" followed by two digits which will identify the period of integration for the selected magnitude.

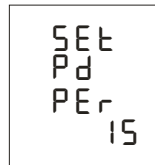

To write or change the value of the integration period repeatedly press the **MAX** key increasing the value of the digit which is flashing at the time.

When the required value is on the screen, move on to the following digit by pressing **MIN**, to allow the remaining values to be changed.

When the last digit has been changed, press **MIN** to move back to the first digit, allowing the previously set values to be changed again.

The integration period may vary between 1 to 60 minutes.

To enter the data and access the following setting step, press .

- *Deletion of maximum Demand*

The display shows "CLr Pd no..".



To select one of the two display options, just press the **MAX** key and the two options will alternate.

Once the required option is selected, press the  key to enter the data and access the following setting step.

4. *Setting the main page and preferred energy*

- *Preferred page and fixed or rotating mode*

The display shows "SEt dEF PAGE URrS".



Fixed page: Default value display when switched on or the CVM-NRG 96 started.

The **MIN** key has to be repeatedly pressed until the required default page is displayed; to enter the page and access the following step the  key has to be pressed.

Rotating page: Display of all electrical parameters using the automatic rotation of the 12 screens in intervals of 5 seconds.

The **MIN** key has to be repeatedly pressed until all of the electrical magnitudes flash; to enter the rotating function and access the following step, the  key has to be pressed.

- *Preferred Magnitude of Energy*

The display shows "SEt dEF PAGE ENEr" and the Active Energy symbol (*kWh*) flashes.



By repeatedly pressing the **MAX** key the required energy magnitude is selected. This may be:

Magnitude of Energy	Direction	Symbol
Active Energy	Consumption	<i>kW·h</i>
Inductive Reactive Energy	Consumption	<i>kvarL·h</i>
Capacitive Reactive Energy	Consumption	<i>kvarC·h</i>
Apparent Energy	Consumption	<i>kVA·h</i>
Active Energy	Generation (-)	- <i>kW·h</i>
Inductive Reactive Energy	Generation (-)	- <i>kvarL·h</i>
Capacitive Reactive Energy	Generation (-)	- <i>kvarC·h</i>
Apparent Energy	Generation (-)	- <i>kVA·h</i>

Once the energy has been selected press the  key to enter the data and access the next setting step

5. *Backlight (Backlit display).*

- *Backlight timer*

The display shows "SEt d! SP oFF".

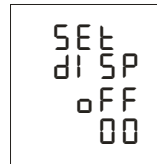

Indicates the screen protector time (*in seconds*), disconnecting the Backlight.

- 00 Backlight permanently on
 01 ... 60 Backlight on from 1 to 60 seconds.

These values(t), refer to the time from the last time the equipment was used via the keypad.

6. Deletion of Energy meters.

- *Deletion of the eight Energy meters*

The display shows "CLr EnEr no".



To select one of the two display options, just press the **MAX** key and the two options will alternate.

Once the required option is selected, press the  key to enter the data and access the following setting step.

7. Setting THd or d

- *Selecting Harmonic Distortion Analysis*

The display shows "SEt hAr tHd".



Thd %: Total value of harmonic distortion referred to the true effective value (RMS).
d %: Total value of harmonic distortion referred to the fundamental value(RMS).

To select one of the two display options, just press the **MAX** key and the two options will alternate.

Once the required option is selected, press the  key to enter the data and access the following setting step.

8. Digital output for the transistor.

The CVM-NRG96's digital output may set:

- a. *Pulse per n kW.h or kvar.h (Energy)*: the value for the energy consumed or generated may be set to generate a pulse.
- b. *Alarm condition*: associates a magnitude to a digital output, setting a maximum, minimum and delay (*delay*) for the trip condition.

In the event that no variable needs to be set, put 00 and enter using the  key.

The display shows "Out UAr Code".

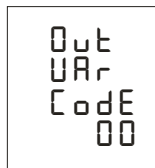

- *Setting pulse per n kW.h or kvar.h*

Energy code table:

Magnitude	Symbol	Code
Active Energy III	<i>kW·h III</i>	31
Inductive Reactive Energy III	<i>KvarL·h III</i>	32
Capacitive Reactive Energy III	<i>KvarC·h III</i>	33
Apparent Energy III	<i>kVA·h III</i>	44
Active energy Generated III	<i>kW·h III (-)</i>	45
Inductive Reactive Energy Generated III	<i>KvarL·h III (-)</i>	46
Capacitive Reactive Energy Generated III	<i>KvarC·h III (-)</i>	47
Apparent Energy Generated III	<i>kVA·h III (-)</i>	48

Once the energy code has been selected and entered using the  key the watts per pulse must be entered or as a default kilowatts per pulse.

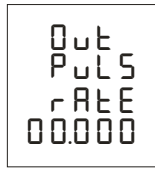

Example: 000.500 500 watts-h/pulse
 00 1.500 1.5 kilowatts-h/pulse

To write or change the watts. hour/pulse, the **MAX** key has to be repeatedly pressed, increasing the value of the digit flashing at the time.

When the required value is on the screen, move on to the following digit by pressing **MIN**, to allow the remaining values to be changed.

When the last digit has been changed, press **MIN** to move back to the first digit, allowing the previously set values to be changed again.

Once the required option is selected, press the  key to enter the data and so finish the equipment configuration.

- *Setting alarm condition*

Alarm code table per condition:

Magnitude	Phase	Symbol L1	Code
Simple Voltage	L1	V 1	01
Current	L1	A 1	02
Active Power	L1	kW 1	03
Reactive Power L/C	L1	KvarL/C 1	04
Power Factor	L1	PF 1	05
% THD V	L1	THD V1	25
% THD A	L1	THD A1	28
Simple Voltage	L2	V 2	06
Current	L2	A 2	07
Active Power	L2	kW 2	08
Reactive Power L/C	L2	KvarL/C 2	09
Power Factor	L2	PF 2	10
% THD V	L2	THD V2	26
% THD A	L2	THD A2	29

Magnitude	Phase	Symbol L1	Code
Simple Voltage	L3	V 3	11
Current	L3	A 3	12
Active Power	L3	kW 3	13
Reactive Power L/C	L3	KvarL/C 3	14
Power Factor	L3	PF 3	15
% THD V	L3	THD V3	27
% THD A	L3	THD A3	30

Magnitude	Symbol	Code
Simple Voltages	V1 / V2 / V3	90
Currents	A1 / A2 / A3	91
Active Powers	kW1 / kW2 / kW3	92
Reactive Powers	Kvar1 / kvar2 / kvar3	93
Power Factors	PF1 / PF2 / PF3	94
Compound Voltages	V12 / V23 / V31	95
% THD V	Thd1 / Thd2 / Thd3 V	96
% THD I	Thd1 / Thd2 / Thd3 A	97

Magnitude	Symbol	Code	Magnitude	Symbol	Code
Active Power III	kW III	16	cos φ three phase	cos φ	19
Inductive Power III	kvarL III	17	Power Factor III	PF III	20
Capacitive Power III	kvarC III	18	Frequency	Hz	21
Active Energy	kW-h	31	L1- L2 Voltage	V 12	22
React. Energy Inductive	Kvarh-L	32	L2-L3 Voltage	V 23	23
React. Energy Capacit.	Kvarh-C	33	L3-L1 Voltage	V 31	24
Apparent Power III	kV-A III	34			
Maximum Demand	Md (Pd)	35	Maximum Demand L1	Md (Pd)	35*
Current III	AIII	36	Maximum Demand L2	Md (Pd)	42*
Neutral Current	I _N	37	Maximum Demand L3	Md (Pd)	43*

* Variables only valid if the Maximum Demand for current has been set per phase.



There are also some variables which refer to the three phases at the same time (*Function OR*). If one of these variables has been selected, the alarm will go off when any of the three phases meet the preset conditions.

Magnitude	Symbol	Code
Simple Voltages	V1 / V2 / V3	90
Currents	A1 / A2 / A3	91
Active Powers	kW1 / kW2 / kW3	92
Reactive Powers	Kvar1 / kvar2 / kvar3	93
Power Factors	PF1 / PF2 / PF3	94
Compound Voltages	V12 / V23 / V31	95
% THD V	Thd1 / Thd2 / Thd3 V	96
% THD I	Thd1 / Thd2 / Thd3 A	97

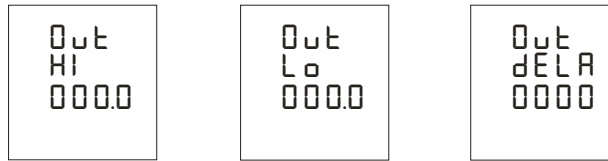
Once the Alarm Condition code has been selected and the data entered using the  key, the *maximum value*, *minimum value* and the *delay* (hysteresis) for the alarm condition must be entered.



- *Hi*: Maximum value; transistor closed above this value.
- *Lo*: Minimum value; transistor closed below this value.
- *Delay*: Delay in seconds from the connection and disconnection of the transistor.

To write or change the maximum and minimum values, the **MAX** key has to be pressed, increasing the value of the digit flashing at the time. When the required value is on the screen, move on to the following digit by pressing **MIN**, to allow the remaining values to be changed. When the last digit has been changed, press **MIN** to move back to the first digit, allowing the previously set values to be changed again. In order to enter one of the data, press the  key moving on to the next setting step. Once the delay has been set, the  key must be pressed entering the data and ending the configuration.

MIN +	MAX + max > min	<table style="width: 100%; border-collapse: collapse;"> <tr> <td style="text-align: center;">ON</td> <td style="text-align: center;">OFF</td> <td style="text-align: center;">ON</td> </tr> <tr> <td style="text-align: center;"> ----- ----- ===== ----- </td> <td></td> <td></td> </tr> <tr> <td style="text-align: center;">0</td> <td style="text-align: center;">Min</td> <td style="text-align: center;">Max</td> </tr> </table>	ON	OFF	ON	----- ----- ===== -----			0	Min	Max
ON	OFF	ON									
----- ----- ===== -----											
0	Min	Max									
MIN +	MAX + max < min	<table style="width: 100%; border-collapse: collapse;"> <tr> <td style="text-align: center;">OFF</td> <td style="text-align: center;">ON</td> <td style="text-align: center;">OFF</td> </tr> <tr> <td style="text-align: center;">===== ===== ----- ===== </td> <td></td> <td></td> </tr> <tr> <td style="text-align: center;">0</td> <td style="text-align: center;">Max</td> <td style="text-align: center;">Min</td> </tr> </table>	OFF	ON	OFF	===== ===== ----- =====			0	Max	Min
OFF	ON	OFF									
===== ===== ----- =====											
0	Max	Min									
MIN --	MAX +	<table style="width: 100%; border-collapse: collapse;"> <tr> <td style="text-align: center;">ON</td> <td style="text-align: center;">OFF</td> <td style="text-align: center;">ON</td> </tr> <tr> <td style="text-align: center;"> ----- ===== ===== ----- </td> <td></td> <td></td> </tr> <tr> <td style="text-align: center;">Min</td> <td style="text-align: center;">0</td> <td style="text-align: center;">Max</td> </tr> </table>	ON	OFF	ON	----- ===== ===== -----			Min	0	Max
ON	OFF	ON									
----- ===== ===== -----											
Min	0	Max									
MIN +	MAX --	<table style="width: 100%; border-collapse: collapse;"> <tr> <td style="text-align: center;">OFF</td> <td style="text-align: center;">ON</td> <td style="text-align: center;">OFF</td> </tr> <tr> <td style="text-align: center;">===== ----- ----- ===== </td> <td></td> <td></td> </tr> <tr> <td style="text-align: center;">Max</td> <td style="text-align: center;">0</td> <td style="text-align: center;">Min</td> </tr> </table>	OFF	ON	OFF	===== ----- ----- =====			Max	0	Min
OFF	ON	OFF									
===== ----- ----- =====											
Max	0	Min									
MIN --	MAX -- max > min	<table style="width: 100%; border-collapse: collapse;"> <tr> <td style="text-align: center;">ON</td> <td style="text-align: center;">OFF</td> <td style="text-align: center;">ON</td> </tr> <tr> <td style="text-align: center;"> ----- ===== ----- ----- </td> <td></td> <td></td> </tr> <tr> <td style="text-align: center;">Min</td> <td style="text-align: center;">Max</td> <td style="text-align: center;">0</td> </tr> </table>	ON	OFF	ON	----- ===== ----- -----			Min	Max	0
ON	OFF	ON									
----- ===== ----- -----											
Min	Max	0									
MIN --	MAX -- max < min	<table style="width: 100%; border-collapse: collapse;"> <tr> <td style="text-align: center;">OFF</td> <td style="text-align: center;">ON</td> <td style="text-align: center;">OFF</td> </tr> <tr> <td style="text-align: center;">===== ----- ===== ===== </td> <td></td> <td></td> </tr> <tr> <td style="text-align: center;">Max</td> <td style="text-align: center;">Min</td> <td style="text-align: center;">0</td> </tr> </table>	OFF	ON	OFF	===== ----- ===== =====			Max	Min	0
OFF	ON	OFF									
===== ----- ===== =====											
Max	Min	0									

* The alarms depend on the preset values: MAXIMUM and MINIMUM

Setting **COMMUNICATION SETUP** *(Only for models with communication)

One or more CVM-NRG96 instruments may be connected to a computer or PLC in order to automatize a production process or an energy control system. As well as the usual operation of each instrument, this system may centralize data at one single point; for this reason the CVM-NRG96 has an RS-485 communication output. If more than one instrument is connected to one single series line (RS-485), it is necessary to assign to each a number or address (from 01 to 255) so that the central computer or PLC sends the appropriate requests to these addresses for each peripheral.

From communication SETUP, the CVM-NRG96's communication parameters may be displayed and/or changed, this may match these parameters to the requirements of the system topologies and/or applications.

The analyzer does not store the setting changes until all of the setting has been finished. If it is **RESET** before the end of the setting, the configuration entered is not stored in the memory.



To access **COMMUNICATIONS SETUP** the **RESET** key has to be pressed (until the equipment starts) and then the **MAX**, **MIN** and keys have to be pressed until setting mode is entered.

On entering setting mode the message "SEtUP InIc" appears for a few seconds, informing the user that the equipment has entered communications display or setting mode.

Below the display shows "SEt Prot bUS"



Using this information screen, the equipment is informing the user that the Communication Protocol via the RS-485 series port is standard **MODBUS**®.

To enter setting mode the key must be pressed.

1. Setting the communication parameters

- *Default settings (factory settings)*

The display shows "SEt [dEF nO"



To select one of the two display options, just press the **MAX** key and the two options will alternate.

SEt [dEF nO	Personalized communication parameters.
SEt [dEF YES	Peripheral: 001
	Transmission speed: 9,600 bps
	Data bits: 8
	Parity No
	Stop bits 1

Once the required option is selected, press the  key to enter the data and access the following setting step.

If the selected option is "SEt [dEF YES" the configuration screens refer to: *peripheral number*, *speed*, *data bits*, *parity* and *stop bits*, are omitted moving on to the last screen in the communication menu.

If the selected option is "SEt [dEF nO":

- *Peripheral number*

The display shows "SEt nPEr 001".



To write or change the number of the peripheral repeatedly press the **MAX** key increasing the value of the digit which is flashing at the time.
 When the required value is on the screen, move on to the following digit by pressing **MIN**, to allow the remaining values to be changed.
 When the last digit has been changed, press **MIN** to move back to the first digit, allowing the previously set values to be changed again.
 The peripheral number varies between 0 and 255 (0 and FF in hexadecimal)
 To enter the data and access the following setting step, press .

- *Transmission speed*

The display shows "SEt bAud rAtE 9600"



To vary the peripheral transmission speed repeatedly press **MAX** changing the value of the different communications options.

Available speeds are: 1,200, 2,400, 4,800, 9,600 or 19,200 bps.

Once the required selection has been made, the next setting step is accessed by pressing the  key.

- *Parity*

The display shows "SEt PARi tY nO"



To select one of the two display options, just press the **MAX** key and the two options will alternate.

Once the required option is selected, press the  key to enter the data and access the following setting step.

- *Data Bits*

The display shows "SEt dAtA bItS 8"



This menu option is solely for information, because data bits cannot be changed.

Then press the  key to enter the data and access the following setting step.

- *Stop Bits*

The display shows "SEt StOp bItS 1"



To select one of the two display options, just press the **MAX** key and the two options will alternate.

Once the required option is selected, press the  key to enter the data and access the following setting step.

2. Protection of measurement SETUP

The display shows "SEt UP unLo"

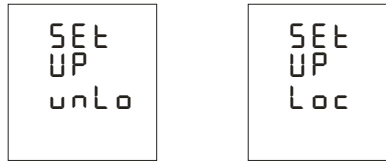

This menu option aims to protect the data set in the *Measurement Setup*. As a default the equipment does NOT protect data with the "unLo.. oPEt on And bY PRESSInG tHE [↔] _EY enters the data and ends the configuration of the equipment.

If on the other hand the parameters in *Measurement Setup* are to be protected, the option "Loc" has to be selected using the **MAX** key and then the [↔] key must be pressed. The protection password as a default will always be **1234**; any password code entered will be incorrect.

The display shows on the screen



To write the protection password **1234**, the **MAX** key has to be repeatedly pressed, increasing the value of the digit flashing at the time. When the required value is on the screen, move on to the following digit by pressing **MIN**, to allow the remaining values to be changed. When the last digit has been changed, press **MIN** to move back to the first digit, allowing the previously set values to be changed again. Once the password protection has been set, the [↔] key must be pressed, entering the data and ending the configuration of the equipment.

In the event that the measurement SETUP parameters are to be changed again, the equipment has to be first unlocked by the same procedure (position Loc and the appropriate changes are made).

MODBUS[®] Protocol

The **CVM-NRG96** power analyzers communicate by using MODBUS[®] protocol, described below:

In the MODBUS protocol the RTU (Remote terminal Unit) mode is used; each 8-bit byte in a message contains two 4-bits hexadecimal characters.

The format for each byte in RTU mode

Code	8 bit binary, hexadecimal 0-9, A-F 2 hexadecimal characters contained in each 8-bit field in the message.
Bits per byte	8 data bits
Field Check-Error	CRC Type (Cyclical Redundancy Check)

Modbus functions used

Function 01	Reading the status of the relays
Function 03 and 04	Reading n Words (16 bits-2 bytes). Function used for reading the electrical parameters that the CVM-NRG96 is measuring. All electrical parameters are long with 32 bits, because of this two Words are required to request each parameter. (4 bytes - XX XX XX XX)
Function 05	Writing a relay.

MODBUS[®] memory map

MODBUS VARIABLES					
Magnitude	Symbol	Instant	Maximum	Minimum	Unit
Voltage Phase	<i>V L1</i>	00-01	60-61	C0-C1	V x10
Current	<i>A L1</i>	02-03	62-63	C2-C3	mA
Active Power	<i>kW L1</i>	04-05	64-65	C4-C5	w
Reactive Power	<i>Kvar L1</i>	06-07	66-67	C6-C7	w
Power Factor	<i>PF L1</i>	08-09	68-69	C8-C9	x 100
Voltage Phase	<i>V L2</i>	0A-0B	6A-6B	CA-CB	V x10
Current	<i>A L2</i>	0C-0D	6C-6D	CC-CD	mA
Active Power	<i>kW L2</i>	0E-0F	6E-6F	CE-CF	w
Reactive Power	<i>Kvar L2</i>	10-11	70-71	D0-D1	w
Power Factor	<i>PF L2</i>	12-13	72-73	D2-D3	x 100
Voltage Phase	<i>V L3</i>	14-15	74-75	D4-D5	V x10
Current	<i>A L3</i>	16-17	76-77	D6-D7	mA
Active Power	<i>kW L3</i>	18-19	78-79	D8-D9	W
Reactive Power	<i>Kvar L3</i>	1A-1B	7A-7B	DA-DB	W
Power Factor	<i>PF L3</i>	1C-1D	7C-7D	DC-DD	x 100
Active Power III	<i>kW III</i>	1E-1F	7E-7F	DE-DF	w
Inductive Power III	<i>KvarL III</i>	20-21	80-81	E0-E1	w
Capacitive Power III	<i>KvarC III</i>	22-23	82-83	E2-E3	w
Cos φ III	<i>Cos φ III</i>	24-25	84-85	E4-E5	x 100
Power Factor III	<i>PF III</i>	26-27	86-87	E6-E7	x 100
Frequency	<i>Hz</i>	28-29	88-89	E8-E9	Hz x 10
Voltage Line L1-L2	<i>V12</i>	2A-2B	8A-8B	EA-EB	V x10
Voltage Line L2-L3	<i>V23</i>	2C-2D	8C-8D	EC-ED	V x10
Voltage Line L3-L1	<i>V31</i>	2E-2F	8E-8F	EE-EF	V x10
% THD V L1	<i>%THD VL1</i>	30-31	90-91	F0-F1	% x 10
% THD V L2	<i>%THD VL2</i>	32-33	92-93	F2-F3	% x 10
% THD V L3	<i>%THD VL3</i>	34-35	94-95	F4-F5	% x 10
% THD A L1	<i>%THD AL1</i>	36-37	96-97	F6-F7	% x 10
% THD A L2	<i>%THD AL2</i>	38-39	98-98	F8-F9	% x 10
% THD A L3	<i>%THD AL3</i>	3A-3B	9A-9B	FA-FB	% x 10
Apparent Power III	<i>KvaIII</i>	42-43	A2-A3	102-103	w
Maximum Demand	<i>Md (Pd)</i>	44-45	A4-A5	104-105	w/VA/mA
Three Phase Current (average)	<i>A_AVG</i>	46-47	A6-A7	106-107	mA
Neutral Current	<i>In</i>	48-49	A8-A9	108-109	mA
Maximum Demand A2	<i>Md (Pd)</i>	52-53	B2-B3	112-113	mA
Maximum Demand A3	<i>Md (Pd)</i>	54-55	B4-B5	114-115	mA

MODBUS VARIABLES					
Magnitude	Symbol	Instant	Maximum	Minimum	Unit
Active Energy	<i>kWh III</i>	3C-3D	9C-CD	FC-FD	w·h
Inductive Reactive Energy	<i>kvarL·h III</i>	3E-3F	9E-9F	FE-FF	w·h
React. Energy Capacitive	<i>kvarC·h III</i>	40-41	A0-A1	100-101	w·h
Apparent Energy	<i>kVA·h III</i>	56-57	B6-B7	116-117	w·h
Active energy Generated	<i>kWh III (-)</i>	58-59	B8-B9	118-119	w·h
Inductive energy generated	<i>kvarL·h III (-)</i>	5A-5B	BA-BB	11A-11B	w·h
Capacit. Energy Generated	<i>kvarC·h III (-)</i>	5C-5D	BC-BD	11C-11D	w·h
Apparent Energy Generated	<i>kVA·h III (-)</i>	5E-5F	BE-BF	11E-11F	w·h

*Recordings available in HAR model					
MODBUS VARIABLES					
Magnitude	Symbol	L1	L2	L3	Unit
Harmonic decomposition in VOLTAGE		Instant			
RMS Current	V	2AE-2AF	2CC-2CD	2EA-2EB	Vx10
Harmonic 2		2B0-2B1	2CE-2CF	2EC-2ED	%
Harmonic 3		2B2-2B3	2D0-2D1	2EE-2EF	%
Harmonic 4		2B4-2B5	2D2-2D3	2F0-2F1	%
Harmonic 5		2B6-2B7	2D4-2D5	2F2-2F3	%
Harmonic 6		2B8-2B9	2D6-2D7	2F4-2F5	%
Harmonic 7		2BA-2BB	2D8-2D9	2F6-2F7	%
Harmonic 8		2BC-2BD	2DA-2DB	2F8-2F9	%
Harmonic 9		2BE-2BF	2DC-2DD	2FA-2FB	%
Harmonic 10		2C0-2C1	2DE-2DF	2FC-2FD	%
Harmonic 11		2C2-2C3	2E0-2E1	2FE-2FF	%
Harmonic 12		2C4-2C5	2E2-2E3	300-301	%
Harmonic 13		2C6-2C7	2E4-2E5	302-303	%
Harmonic 14		2C8-2C9	2E6-2E7	304-305	%
Harmonic 15		CA-CB	2E8-2E9	306-307	%
Harmonic decomposition in CURRENT		Instant			
RMS current	A	1F4-1F5	212-213	230-231	mA
Harmonic 2		1F6-1F7	214-215	232-233	%
Harmonic 3		1F8-1F9	216-217	234-235	%
Harmonic 4		1FA-1FB	218-219	236-237	%
Harmonic 5		1FC-1FD	21A-21B	238-239	%
Harmonic 6		1FE-1FF	21C-21D	23A-23B	%
Harmonic 7		200-201	21E-21F	23C-23D	%
Harmonic 8		202-203	220-221	23E-23F	%
Harmonic 9		204-205	222-223	240-241	%
Harmonic 10		206-207	224-225	242-243	%
Harmonic 11		208-209	226-227	244-245	%
Harmonic 12		20A-20B	228-229	246-247	%
Harmonic 13		20C-20D	22A-22B	248-249	%
Harmonic 14		20E-20F	22C-22D	24A-24B	%
Harmonic 15		210-211	22E-22F	24C-24D	%

Example of a MODBUS® question**QUESTION****0A 04 00 00 00 0A 71 76**

0A	Peripheral number, 10 in decimal
04	Reading function
00 00	Record at which the reading is to start
00 0A	Number of recording to be read: 10 in decimal
71 76	CRC Character

RESPONSE**0A 04 14 00 00 08 4D 00 00 23 28 00 00 0F A0 00 00 00 90 00 00 00 60 CB 2E**

0A	Number of the peripheral that is responding, 10 in decimal
04	Reading function- the one used in the question
14	Number of bytes received (20).
00 00 08 4D	V1x 10 (record 00 Hex) with value in decimal 212.5 V
00 00 23 28	mA 1, in decimal 9000 mA
00 00 0F A0	W 1, in decimal 4000 W
00 00 00 90	varL 1, in decimal 144 varL
00 00 00 60	PF1 x 100, in decimal 96
CB 2E	CRC Character

<i>*Each Modbus frame has a maximum limit of 20 variables (40 recordings).</i>
--

Connection for the RS485 BUS

The composition of the RS-485 cabling must be carried out with a meshed screen cable (minimum 3 wire) with a maximum distance of 1,200 metres between the CVM-NRG96 and the master unit. This Bus may connect a maximum of 32 CVM-NRG96 analyzers.

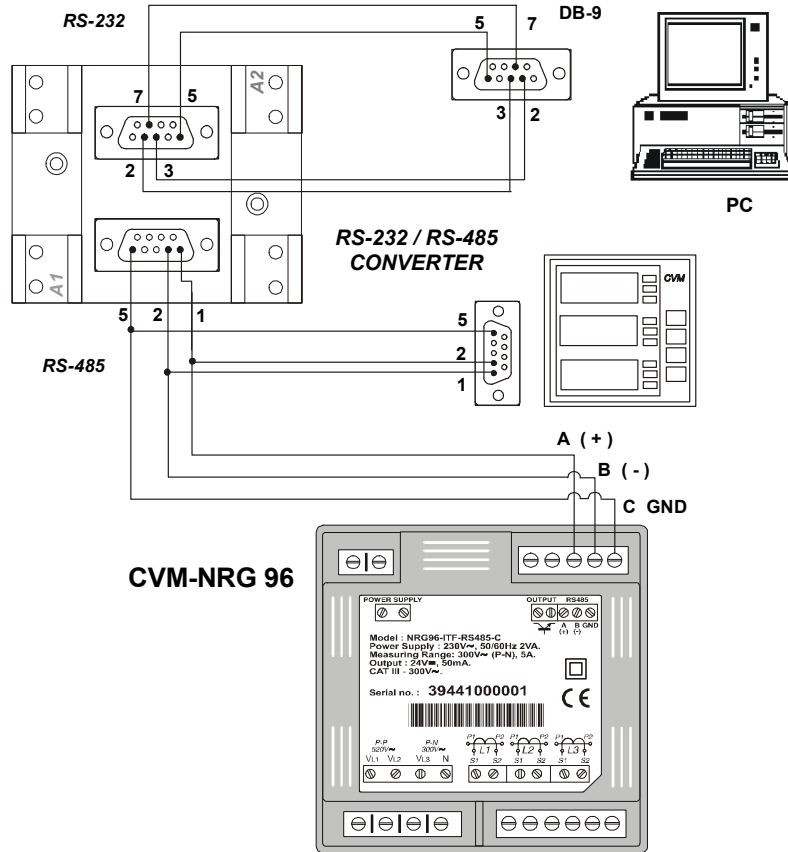

For communication with the master unit, the RS-232 to RS-485 System Protocol Intelligent Converter has to be used (M54020 Intelligent Converter). This converter does not require the 7 Pin connection in the RS232 part.

FAQ's

1. The CVM-NRG96 analyzer, once cabled and connected is seen to give a correct voltage and current reading, but shows negative values for active power (generation).

This is an error with the cabling for the current transformer secondaries; the direction of the transformer current has to be respected as shown in the connection diagram. The current transformers have a two face primary; the current must pass from P1 to P2 giving the result in secondary (S1 and S2) of 5 amps.

The error stems from:

- a) *The current transformers have been incorrectly installed. As a result it gives the direction of the current as passing from P2 to P1; to resolve this problem, the current transformer does not have to be dismantled and installed again, but the transformer secondary (S1 and S2) just has to be inverted.*
 - b) *The connection of the current secondaries in the current transformers have been incorrectly connected; to resolve this problem just connect the S1 transformer secondary to the S1 on the analyzer and the S2 on the current transformer to the S2 on the analyzer.*
2. The CVM-NRG96 analyzer, once cabled and connected, is seen to give an incoherent Power factor and Cos ϕ III reading (-0.01 or similar).

This is again a current transformer and voltage phase connection error phase L1 (R), must correspond to the current transformer installed in phase L1 (R); phase L2 (S), must correspond to the current transformer installed in phase L2 (S); and phase L3 (T), must correspond to the current transformer installed in phase L3 (T).

This connection is clearly shown on the back of the analyzer.

3. The CVM-NRG96 analyzer does not correctly display the current reading. It shows values varying between 0 to 5 amps of current.

Ensure that the Transformer Primary ratio has been correctly set; once correctly set the current measurement shall be shown correctly extrapolated to primary (see section on transformer ratios).

4. The CVM-NRG96 analyzer is measuring in average voltage and is displaying the secondary voltage (for example 110 volts).

Ensure that the Primary and Secondary voltage ratio has been correctly set (see section on transformer ratios).

5. The CVM-NRG96 analyzer does not respond to communications requests; it does not communicate.

Ensure that the equipment's communication parameters have been correctly set as well as the peripheral number (0 to FF).

6. The CVM-NRG96 analyzer is connected to the Power Studio System and it does not communicate with the PC.

Ensure that the analyzer has been set with a Bus speed of 19,200 bauds.

CIRCUTOR, SA
Vial Sant Jordi, s/n
08232 Viladecavalls
BARCELONA
SPAIN
Tel. +34 93.745.29.00
Fax. +34 93.745.29.14
web: <http://www.circutor.com>
e-mail: medida@circutor.es

Technical assistance:
After sales department
Vial Sant Jordi, s/n
08232 Viladecavalls
BARCELONA
SPAIN
e-mail: medida@circutor.es